

# MULTIPLE COMPACT DISC PLAYER

## CD-3260M/DPF-J7020

## CD-3280M

# SERVICE MANUAL

# KENWOOD

© 1999-2/B51-5508-00 (K/K) 2945

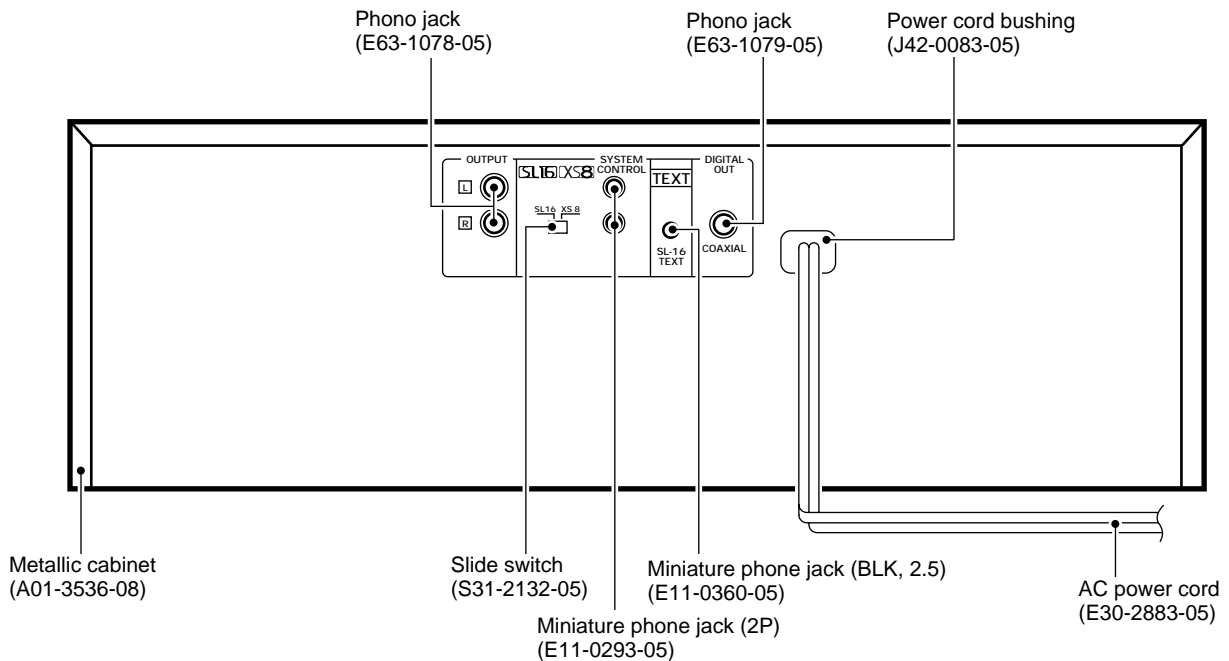
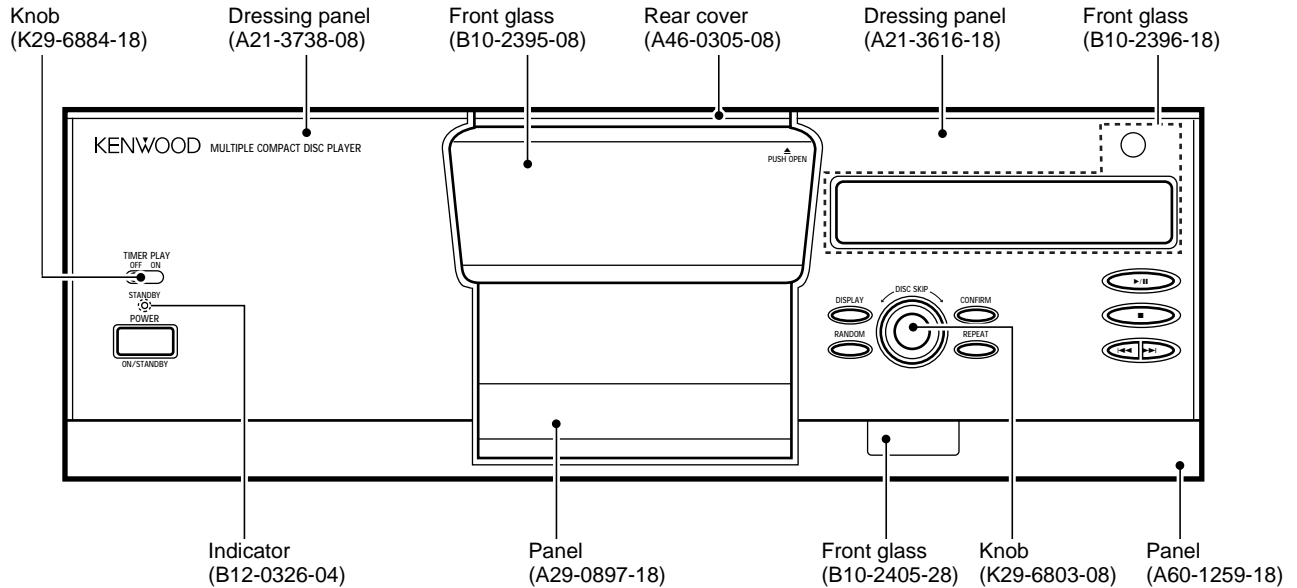

**Illustration is CD-3260M.**

In compliance with Federal Regulations, following are reproductions of labels on, or inside the product relating to laser product safety.

KENWOOD-Crop. certifies this equipment conforms to DHHS Regulations No. 21 DFR 1040. 10, Chapter 1, Subchapter J.

**DANGER : Laser radiation when open and interlock defeated. AVOID DIRECT EXPOSURE TO BEAM**

Please refer to the service manual **CD-223M/DPF-J3010/CD-224M/DPF-J5010 (B51-5409-00)** if need more information.

Refer to CD-2260M/2280M/DPF-J7010/J9010 service manual (B51-5416-00), if you require sub micro-processor (IC3: X25) in detail.



# CD-3260M/3280M/DPF-J7020

## CONTENTS / ACCESSORIES

### Contents

CONTENTS/ACCESSORIES/CAUTIONS.....	2	SCHEMATIC DIAGRAM .....	15
EXTERNAL VIEW .....	3	EXPLODED VIEW .....	26
CIRCUIT DESCRIPTION .....	4	PARTS LIST .....	28
ADJUSTMENT .....	10	SPECIFICATIONS .....	Back cover
PC BOARD .....	11		

### Accessories

Audio cord ..... (1)  
(E30-0505-05)

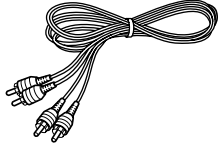

System control cord ..... (1)  
(E30-2816-05)

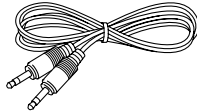

Communication cord ..... (1)  
(E30-2861-05)



Batteries (R6/AA) ..... (2)

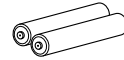

Remote control unit ..... (1)  
(A70-1256-08) : RC-P0708.....CD-3280M

Battery cover (A09-0374-08)

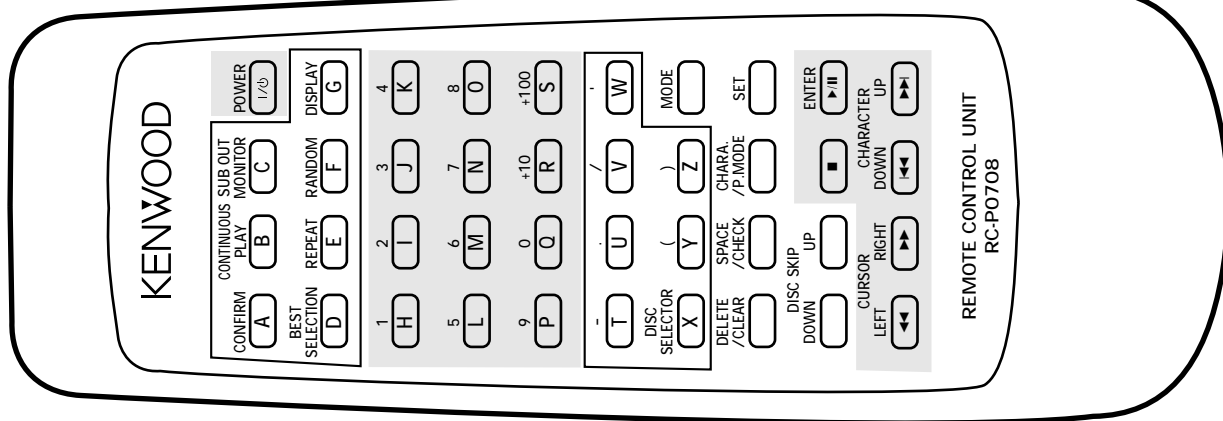

Remote control unit ..... (1)  
(A70-1257-08) : RC-P0709.....CD-3260M/DPF-J7020

Battery cover (A09-0374-08)

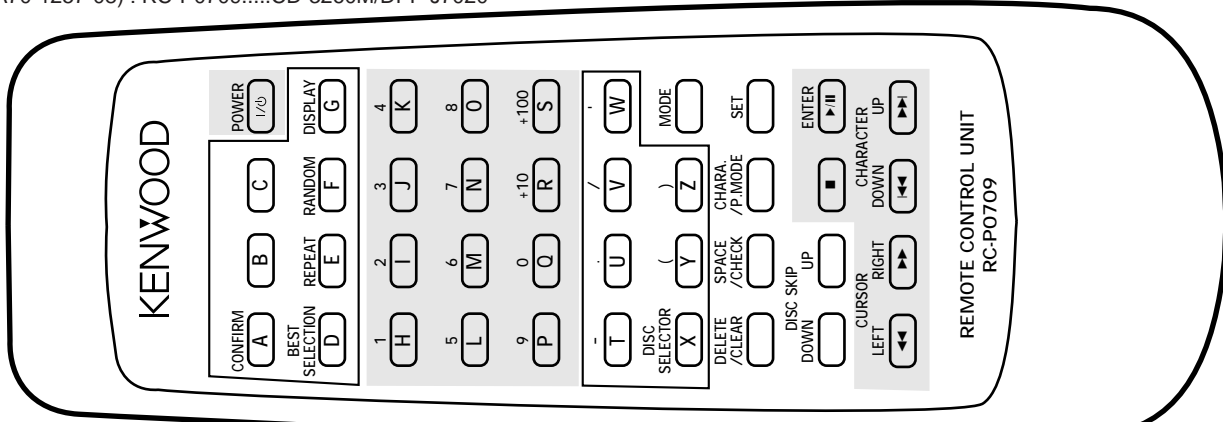

# CD-3260M/3280M/DPF-J7020

## EXTERNAL VIEW

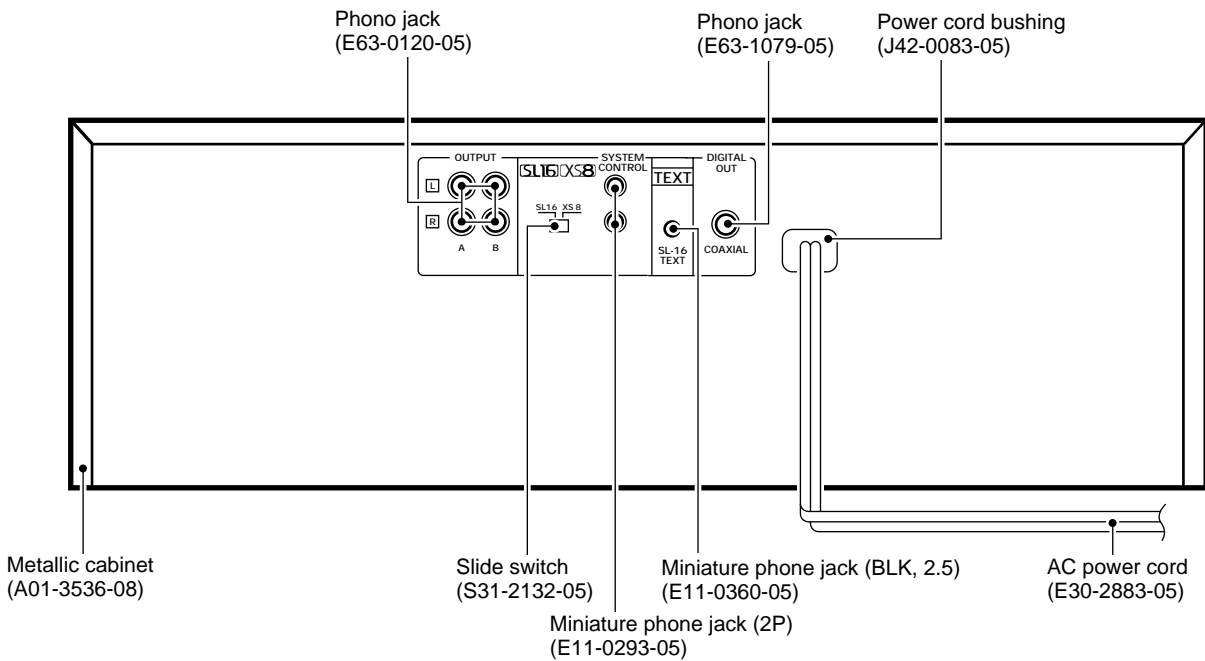
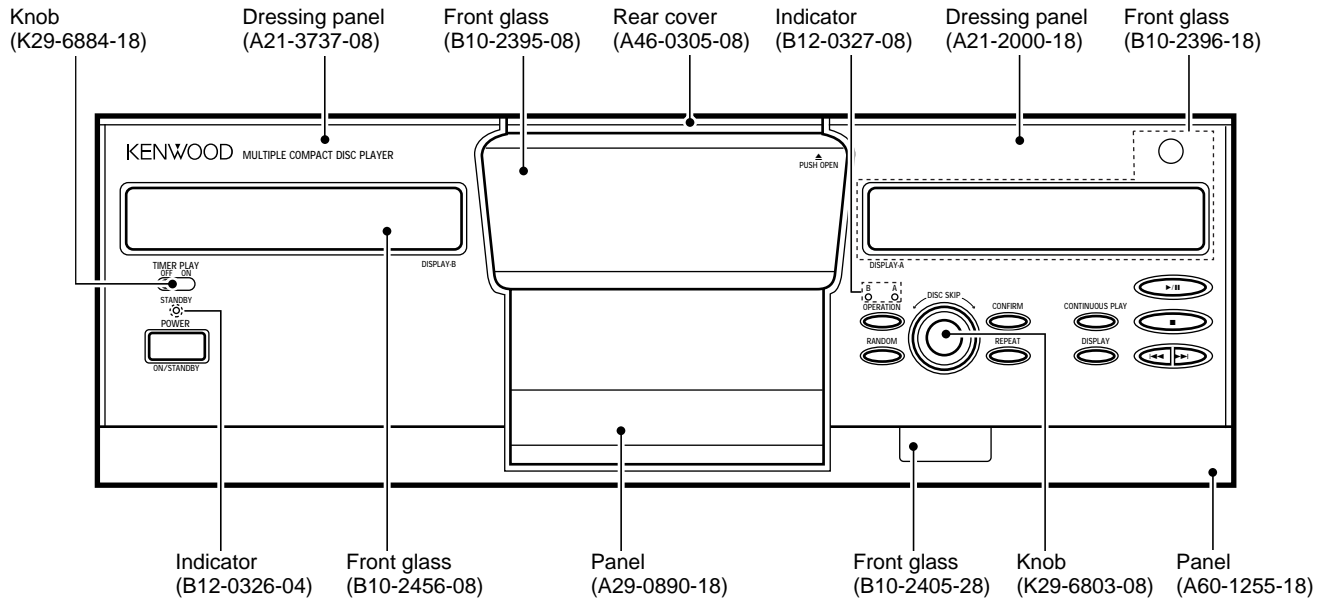

Illustration is CD-3280M.

# CD-3260M/3280M/DPF-J7020

## CIRCUIT DESCRIPTION

### 1. Main microprocessor : uPD784215GF541 (X32, IC8)

#### 1-1 Microprocessor periphery block diagram

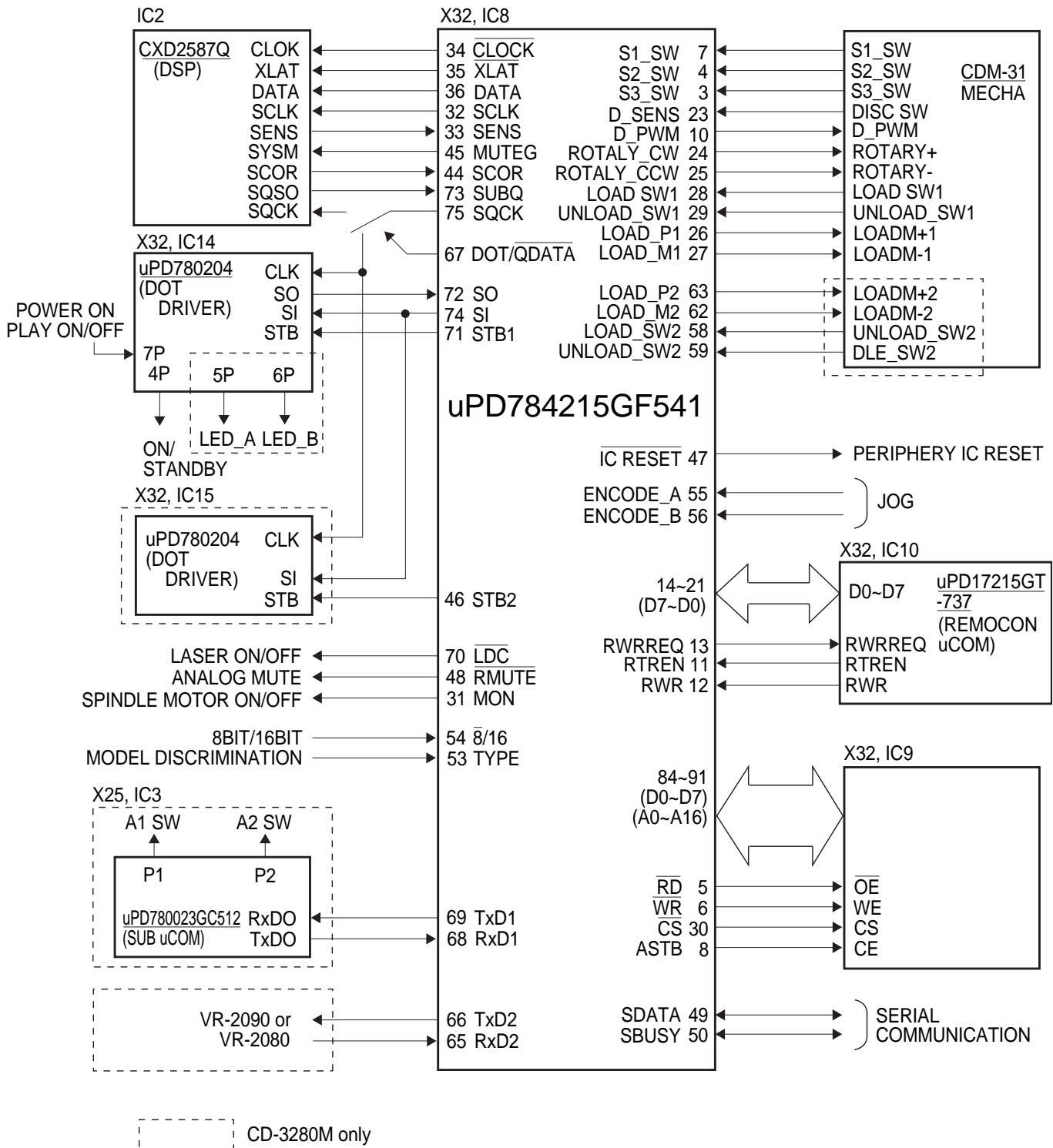

## CIRCUIT DESCRIPTION

## 1-2 Microprocessor pin description (X32, IC8) :UPD784215GF541

Pin No.	Pin Name	I/O	Description
1	A2	O	Address bus of SRAM.
2	NC	-	No connection.
3	S3-SW	I	Mechanism address detector switch.
4	S2-SW	I	Mechanism address detector switch.
5	RD	O	SRAM read strobe.
6	WR	O	SRAM write strobe.
7	S1-SW	I	Mechanism address detector switch.
8	ASTB	O	No connection.
9	VDD	-	Power supply(+5V).
10	+5VPUL	O	Disc sensor ON/OFF. L:on
11	RTRN	I	TX permission data to remote control microprocessor.
12	RWR	I	Reading data of remote control microprocessor.
13	RWRR	O	TX request data to remote control microprocessor.
14-21	L-D7-D0	O	Data output to remote control microprocessor.
22	TEST	-	GND.
23	DISC-SW	I	Disc sensor.
24	ROTARY-CW	O	Mechanism rotary motor(+). H:CCW
25	ROTARY-CCW	O	Mechanism rotary motor(-). H:CW
26	LOADM+1	O	Loading motor(+) for main pickup.
27	LOADM-1	O	Loading motor(-) for main pickup.
28	LOAD-SW1	I	Loading switch for main pickup.
29	UNLOAD-SW1	I	Unloading switch for main pickup.
30	CS	O	Chip selector
31	MON	O	Control port of poor focus works.
32	SCLK	O	Sens serial data read clock.
33	SENS	I	SENS signal input.
34	CLOCK	O	Serial data clock.
35	XLAT	O	CXD2587Q latch. H →: latch
36	DATA	O	Serial data output.
37	VDD	-	Power supply(+5V).
38,39	X1,2	-	Main system clock(12.5MHz).
40	VSS	-	GND.
41	XT2	-	No connection.
42	XT1	I	GND.
43	RESET	I	System reset signal input.
44	SCOR	I	Sub code synchro detection.
45	MUTEG	O	Muting control output. H:muting on.
46	STB2	O	Strobe signal output to dot driver2(CD-3280M only).
47	ICRESET	O	IC reset.
48	SYSM	O	Analog muting. L: Muting on.
49	SDATA	I/O	Serial data signal I/O.
50	SBUSY	I/O	Serial busy signal I/O.
51	AVDD	-	Power supply(+5V).
52	AVREF	-	A/D reference power supply.
53	A/D0	I	Model selector.
54	8/16	I	8/16 bit selector. H:16bit.
55	JOG2	I	Encoder signal A input.

# CD-3260M/3280M/DPF-J7020

## CIRCUIT DESCRIPTION

Pin No.	Pin Name	I/O	Description
56	JOG1	I	Encoder signal B input.
57	DOOR-SW	I	Door open/close detector switch.
58	LOAD-SW2	I	Load switch2 for sub pickup(CD-3280M only).
59	UNLOAD-SW2	I	Unload switch2 for sub pickup(CD-3280M only).
60	DISC-SW2	I	Disc2 sensor(CD-3280M only).
61	VSS	-	GND.
62	LOADM-2	O	Load motor(-) for sub pickup(CD-3280M only).
63	LOADM+2	O	Load motor(+) for sub pickup(CD-3280M only).
64	AVREF1	-	D/A reference power supply.
65	RXD2	I	UART communication input(CD-3280M only).
66	TXD2	O	UART communication output(CD-3280M only).
67	SQCK/SCK-SW	O	SQCK,SCK(DOT/DSP clock) selector. L:DSP.
68	RXD1	I	UART communication input from sub u-com(CD-3280M only).
69	TXD1	O	UART communication output to sub u-com(CD-3280M only).
70	LDC	O	Laser on/off. L: Laser diode on.
71	STB1	O	Strobe signal output to dot driver.
72	S0	I	Data input from dot driver.
73	SQS1	I	Sub code read data input.
74	S1	O	Data output to dot driver.
75	SCK/SQCK	O	Dot driver/sub code read clock.
76-83	A16,14,12,7-3	O	Address output to SRAM.
84-91	D0-7	I/O	SRAM data bus.
92-97	A8-11,13,15	O	Address output to SRAM.
98,99	A0,1	O	Address output to SRAM.
100	VSS	-	GND.

### 1-3 Key matrix ( ) : IC14 Pin No.

VOLTAGE	A/D0(33)	A/D1(32)	A/D2(31)
4.1V	-	-	DISPLAY *OPERATION
3.3V	-	-	RANDOM
2.5V	-	-	CONFIRM
1.6V	-	REPEAT	*CONT.P
0.8V	DOWN	*DISP.	PLAY/PAUSE
0V	UP	POWER	STOP

\* CD-3280M only

## CIRCUIT DESCRIPTION

### 2. FL Microprocessor : UPD 780204-038 (X32-IC14,15) IC15 (CD-3280M only)

#### Pin description

Pin No.	Pin Name	I/O	Description
1	VDD	-	Power supply(+5V)
2,3	NC	-	No connection.
4	STANDBY *LED-D	O	Standby LED control. * No connection.
5	LED-M	O	Main LED control. *No connection.
6	LED-S	O	Sub LED control. *No connection.
7	POW-P *STANDBY	I/O	Timer sw on input. *No connection.
8,9	NC		No connection.
10	RESET	I	System reset input.
11,12	X1,2	-	Main system clock.(5MHz).
13	VSS	-	GND.
14	XT2	-	No connection.
15	XT1	I	GND.
16	VDD	-	Power supply(+5V)
17	SCK	I	Serial clock.
18	SO	O	Data output.
19	SI	I	Data input.
20-24	NC	-	No connection.
25	AVSS	-	GND.
26-30	A/D7-A/D3	-	GND.
31-33	A/D2-A/D0	I	Key return signal input(2-0).
34	AVDD	-	A/D analog power supply.
35	AVREF	-	A/D reference power supply.
36,37	VSS	-	GND.
38	REM	I	Remote control input.
39	STB1 * STB2	I	Strobe signal input.
40	VSS	-	GND.
41-45	NC	-	No connection.
46	VDD	-	Power supply(+5V)
47	NC	-	No connection.
48-52	P1-5	O	FL control output. 1G(▶■),2G-16G(1-1 to 5-1).
53-57	P6-10	O	FL control output. 2G-16G(1-2 to 5-2).
58-62	P11-15	O	FL control output. 2G-16G(1-3 to 5-3).
63,64	P16,17	O	FL control output. 2G-16G(1-4 to 2-4).
65-69	P35-31	O	FL control output. 2G-16G(5-7 to 1-7).
70-74	P30-26	O	FL control output. 2G-16G(5-6 to 1-6).
75-78	P25-22	O	FL control output. 2G-16G(5-5 to 2-5).
79	VLOAD	-	Negative power supply(-37.5V)
80	P21	O	FL control output. 2G-16G(1-5).
81,82	P20,19	O	FL control output. 2G-16G(5-4 ,4-4).
83	NC	-	No connection.
84	P18	O	FL control output. 2G-16G(3-4).
85-92	9G-16G	O	FL control output. 9G-16G.
93-100	8G-1G	O	FL control output. 8G-1G.

\* IC15

# CD-3260M/3280M/DPF-J7020

## CIRCUIT DESCRIPTION

### 3. Test mode

INPUT KEY	PROCEDURE	DISPLAY
Insert the AC plug to the wall outlet with pressing the SKIP-DOWN key.	INITIAL CONDITION <ul style="list-style-type: none"> <li>• Disc No.1 moves to the center.</li> <li>• Clear the memory of the SRAM.</li> <li>• Door opens. —————→</li> <li>• Set the switch of TIMER ON PLAY to ON. —————→</li> <li>• Set the switch of SYSTEM CONTROL to XS8. —————→</li> </ul>	MECHA. INITIAL INITIAL OK!!  INITIAL NG TIMER, NG SER, NG
Insert the AC plug to the wall outlet with pressing the REPEAT key	CIRCUIT ADJUSTMENT <ul style="list-style-type: none"> <li>• Open the door and load the disc to the Disc No.1.</li> <li>• Close the door. The unit changes to test mode05 after clamping the disc.</li> </ul>	TEST ON
PLAY/PAUSE	Change the mode 05(tracking-on) and 03(tracking-off) alternately by the PLAY key.	05 XX:XX 03 XX:XX
STOP	Stop the function.	00
UP	The pickup travels outwards.	MOTOR FORWARD
DOWN	The pickup travels inwards.	MOTOR REVERSE
RANDOM	Shows the result of self-adjustment. 07 EF/FB ← ↓ 08 TG/FG ↓ 09 FE/RF ↓ 10 TE/VC — Mode changes alternately by the RANDOM key.	07 XXX:XXX 08 XXX:XXX 09 XXX:XXX 10 XXX:XXX NG: blinking
DISPLAY	- shows Niagara mode	
POWER	Check the transmission signal(Disc No.1 and Track No.99) of the remote controller. *DPF-J7020 only	
REPEAT	Playback PGM signal of the Track No.7,13,23,30,34 and 41 in the order. And release the test mode.	
CONFIRM	Release the test mode.	
(TIMER PLAY SW)	Check the switch position.	TIMER ON , TIMER OFF
(SL16/XS8 SW)	Check the switch position.	16BIT, 8BIT
Insert the AC plug to the wall outlet with pressing the UP key.	CHECK THE MECHANISM JAMMING. Clamp the Disc No1,2,100,50,200 and 199 in the order.	
Insert the AC plug to the wall outlet with pressing the RANDOM key.	THE MECHANISM TEST MODE. Display shows Niagara until pressing any keys.	
PLAY/PAUSE	Change the mode 05(tracking-on) and 03(tracking-off) alternately by the PLAY key.	05 XX:XX 03X:XX
STOP	Stop the function. Shows the result of self-adjustment. 07 EF/FB ← ↓ 08 TG/FG ↓ 09 FE/RF ↓ 10 TE/VC — Mode changes alternately by the STOP key.	07 XXX:XXX 08 XXX:XXX 09 XXX:XXX 10 XXX:XXX NG: blinking



## CIRCUIT DESCRIPTION

INPUT KEY	PROCEDURE	DISPLAY
UP	Arm Motor Load operation.	MOTOR LOAD
DOWN	Arm Motor Unload operation.	MOTOR UNLOAD
RANDOM	Rotary Motor Clockwise turning.	MOTOR CW
DISPLAY	Rotary Motor Counterclockwise turning.	MOTOR CCW
POWER	Check the transmission signal(Disc No.1 and Track No.99) of the remote controller. *DPF-J7020 only	
REPEAT	Playback PGM signal of the Track No.1,23 and 41 in the order. And release the test mode.	
CONFIRM	Release the test mode.	
(TIMER PLAY SW)	Check the switch position.	TIMER ON , TIMER OFF
(SL16/XS8 SW)	Check the switch position.	16BIT , 8BIT

### 4. Error code

DISPLAY	ERROR CONTENTS
MECHA ERROR 01	No input of S3. The original position error of Disc Number.
MECHA ERROR 02	No input of S2. The turning direction error to counterclockwise
MECHA ERROR 03	No input of S1. The turning direction error to clockwise
MECHA ERROR 04	No input of main load sw.
MECHA ERROR 05	No input of main unload sw.
MECHA ERROR 06	No input of sub load sw.(CD-3280M)
MECHA ERROR 07	No input of sub unload sw.(CD-3280M)
MECHA ERROR 08	No backed up(AC power cord has disconnected).

S1-3:Mechanism address detector switch.

There are load and unload switches in the main pickup.

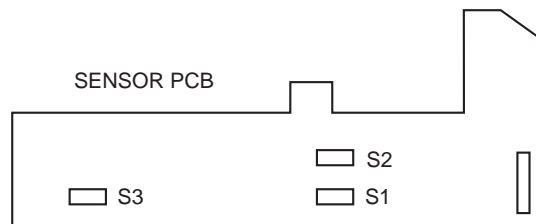

S1 DISC 1~9  
S2 DISC 10~99  
S3 DISC 100~200

# CD-3260M/3280M/DPF-J7020

## ADJUSTMENT

No.	ITEM	INPUT SETTING	OUTPUT SETTING	PLAYER SETTING	ALIGNMENT POINT	ALIGN FOR	FIG.
<b>1. With pressing the REPEAT KEY, turn the power on to enter the test mode.</b> <b>2. Set the Test disc to Disc NO. 1.</b> <b>3. Close the door.</b>							
1	FOCUS ERROR BIAS	Test disc Type4 /KTD-02	Connect an oscilloscope as follows. CH1:RF(* X25, CN2-1 X32, CN2-1) *CD-3280M	Press the PLAY /PAUSE key . Confirm that the display is "05".	FE BIAS VR1	Optimum eye pattern	(d)

Note:

Type 4 disc :SONY YEDS-18 Test Disc or equivalent.

LPF : Around 47k $\Omega$  + 390 pF or so.

**FIG. (d)**

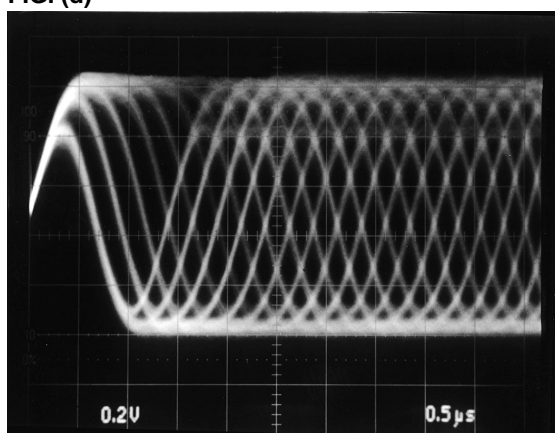

RF signal

- RF signal in test mode (PLAY).
- Perform the tangential and focusing offset are focused into one point on the display. The crossing points above and below the center shall also be looked clearly. (FE BIAS)

# PC BOARD (Component side view)

## SUB-CIRCUIT UNIT

X25-6060-11

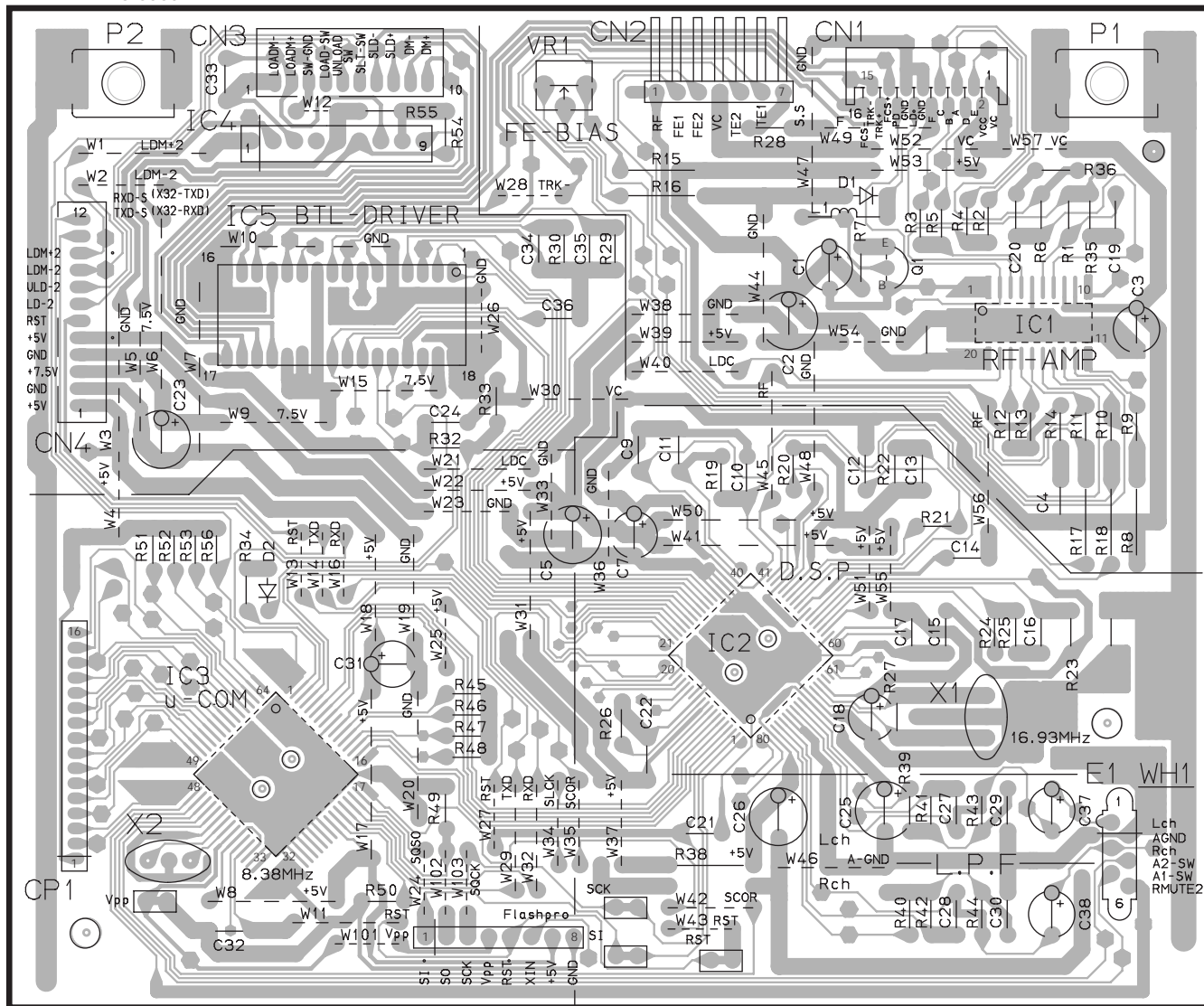

Refer to the schematic diagram for the value of resistors and capacitors.

# PC BOARD (Component side view)

## CD PLAYER UNIT X32-3500-10 A/8

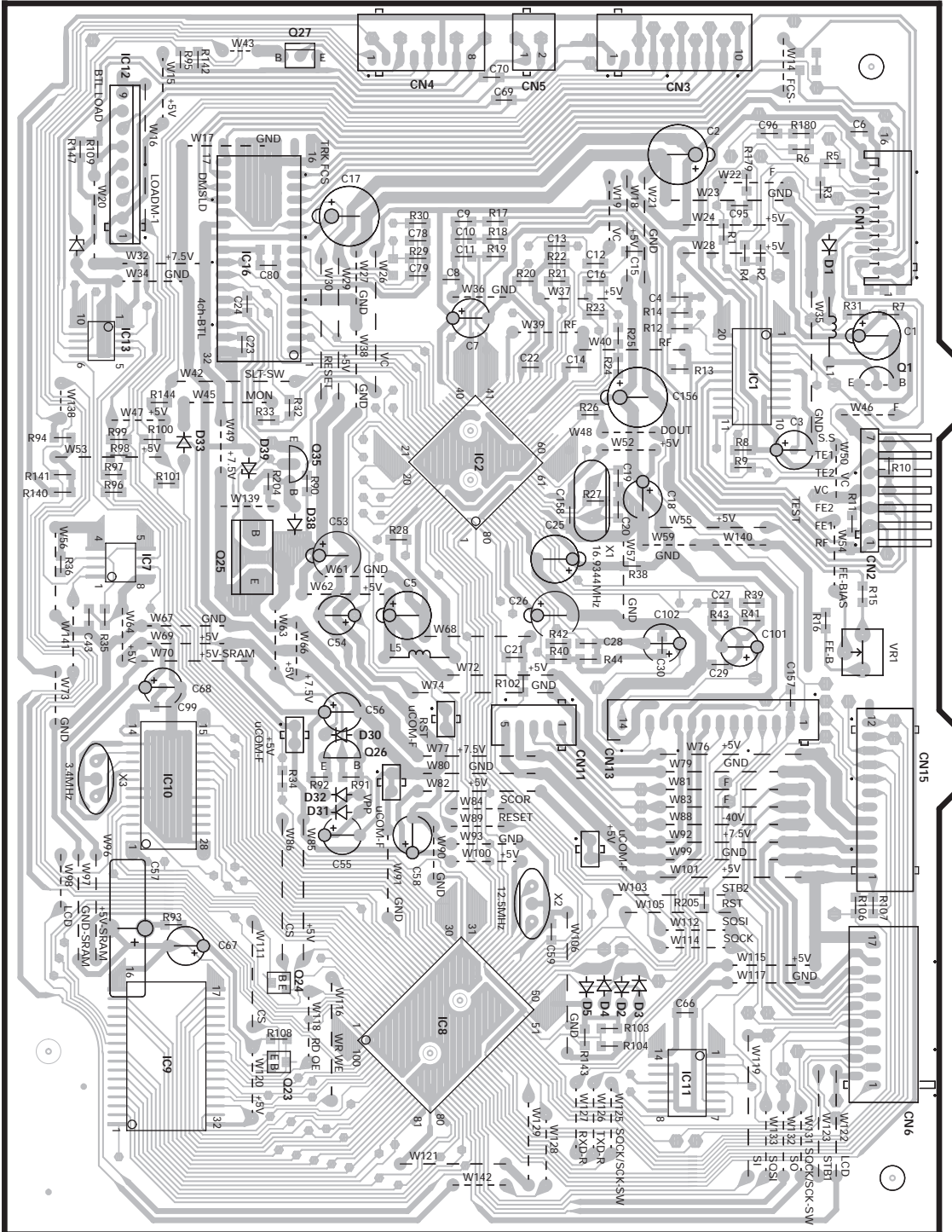

Refer to the schematic diagram for the value of resistors and capacitors.



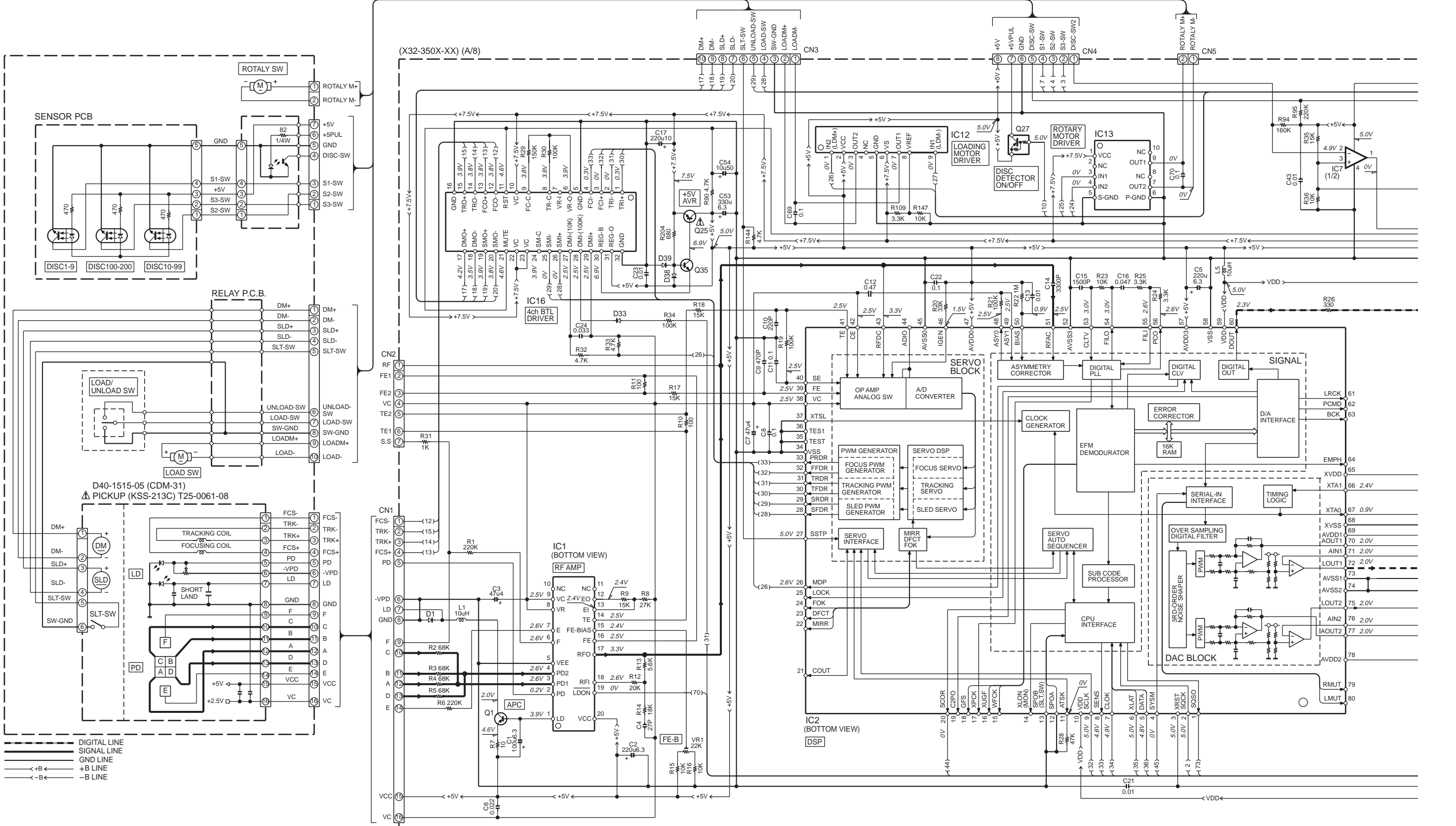

- - - DIGITAL LINE  
 ——— SIGNAL LINE  
 ——— GND LINE  
 ——— +B LINE  
 ——— -B LINE

CD-3260M (X32-3500-12)

DESTINATION COUNTRY	ABB.	UNIT No.	CN15	R104	C158
U.S.A.	K1	0-12	NO	YES	YES
CANADA	P2				

CD-3280M (X32-3500-13)

DESTINATION COUNTRY	ABB.	UNIT No.	CN15	R104	C158
U.S.A.	K	0-13	YES	NO	NO
CANADA	P1				

DPF-J7020 (X32-3502-73)

DESTINATION COUNTRY	ABB.	UNIT No.	CN15	R104	C158
U.K.	T1	2-73	NO	YES	NO
EUROPE	E1				

- IC1 : CXA1571M
- IC2 : CXD2587Q
- IC7 : NJM2100M
- IC8 : uPD784215GF541
- IC9 : 5M51008BFP70LL or 628128BLFP7SL
- IC10 : uPD17215GT-737
- IC11 : TC74HC00AF
- IC12 : TA8409S
- IC13 : LB1930M
- IC16 : BA5979S

- Q1 : 2SA954(L,K)
- Q23 : UN5212 or DTC124EUA
- Q24 : UN5112 or DTA124EUA
- Q25 : 2SB1640 or 2SB1417(P)
- Q26 : 2SC2003(L,K)
- Q27 : UN4119 or DTA113ZSA
- Q35 : 2SC2458(Y,GR) or 2SC3311A(Q,R)

- D1-5,30-33,38 : HSS104 or 1SS133
- D39 : HZ55.1N(B2) or RD5.1ES(B2)

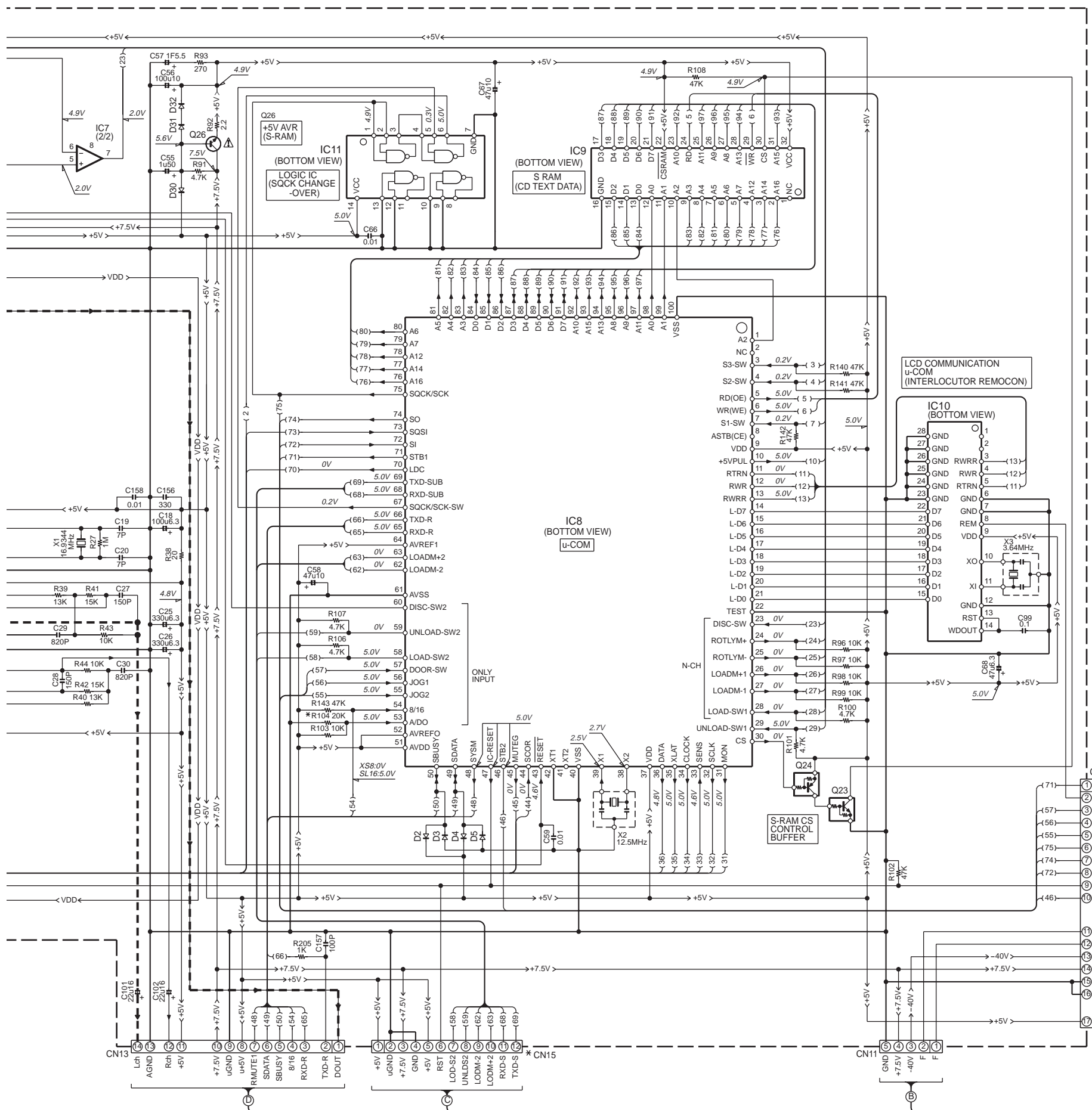

2SA954  
2SC2003  
2SC3246  
2SC3940A

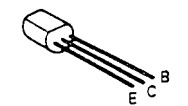

DTA113ZSA  
DTC124ESA  
2SA1048  
2SC2458

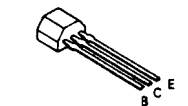

2SA1586

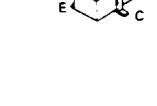

UN4212  
UN4219  
2SA1309A  
2SC3311A

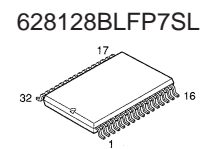
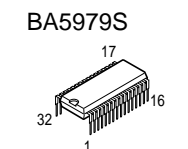
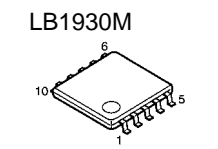
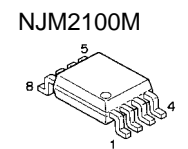
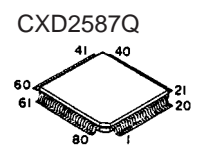
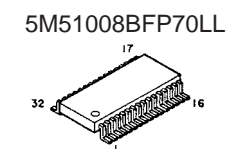
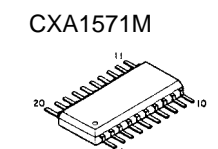
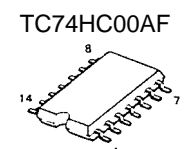
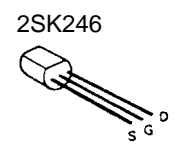
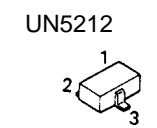
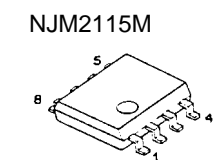
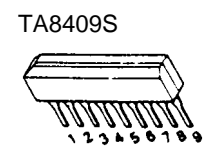
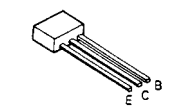

**CAUTION:** For continued safety, replace safety critical components only with manufacturer's recommended parts (refer to parts list).  $\Delta$  indicates safety critical components. For continued protection against risk of fire, replace only with same type and rating fuse(s). To reduce the risk of electric shock, leakage-current or resistance measurements shall be carried out (exposed parts are acceptably insulated from the supply circuit) before the appliance is returned to the customer.

The DC voltage is an actual reading measured with a high impedance type voltmeter. The measurement value may vary depending on the measuring instruments used or on the product. Refer to the voltage during PLAY unless otherwise specified; The value shown in ( ) is the voltage measured at the moment of STOP.





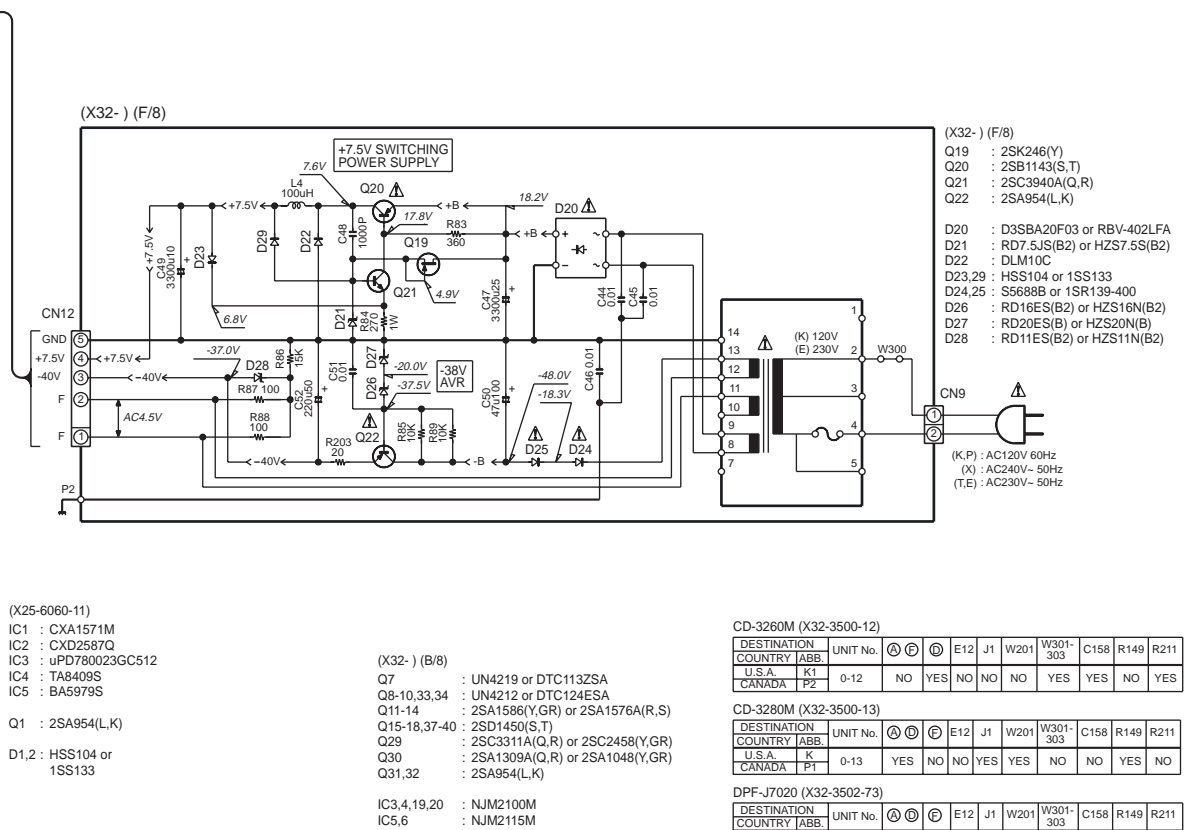
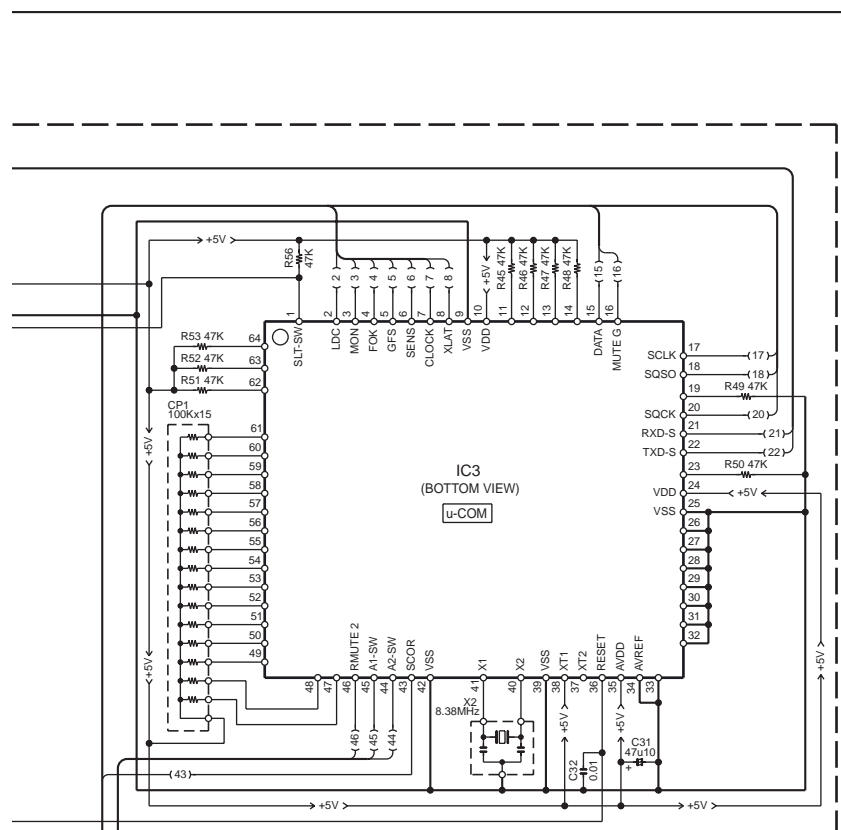

CAUTION: For continued safety, replace safety critical components only with manufacturer's recommended parts (refer to parts list).  $\Delta$  indicates safety critical components. For continued protection against risk of fire, replace only with same type and rating fuse(s). To reduce the risk of electric shock, leakage-current or resistance measurements shall be carried out (exposed parts are acceptably insulated from the supply circuit) before the appliance is returned to the customer.

The DC voltage is an actual reading measured with a high impedance type voltmeter. The measurement value may vary depending on the measuring instruments used or on the product. Refer to the voltage during PLAY unless otherwise specified; The value shown in ( ) is the voltage measured at the moment of STOP.

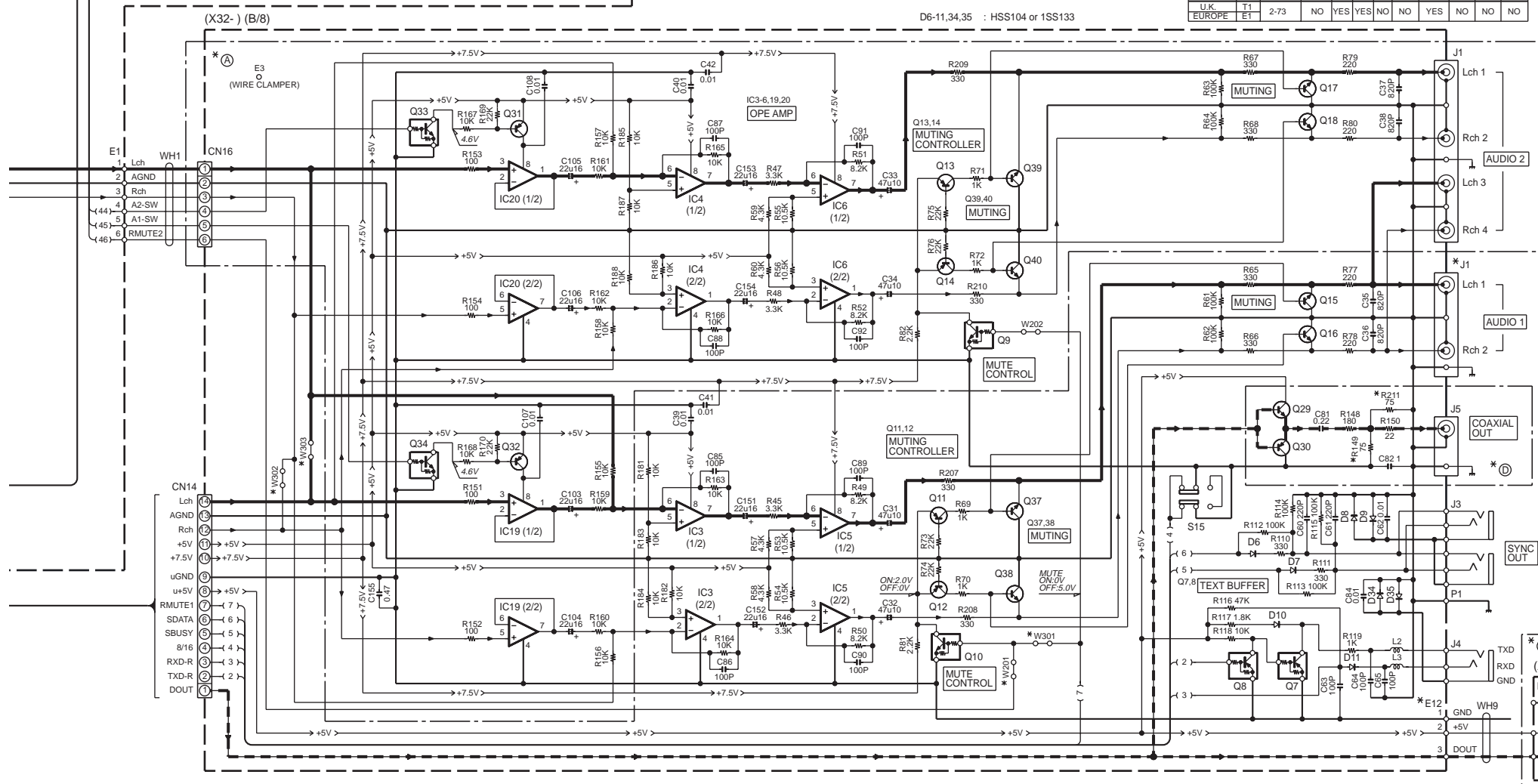

CD-3260M/3280M(K) (2/3)  
DPF-J7020(E) (2/3)

# CD-3260M/3280M/DPF-J7020

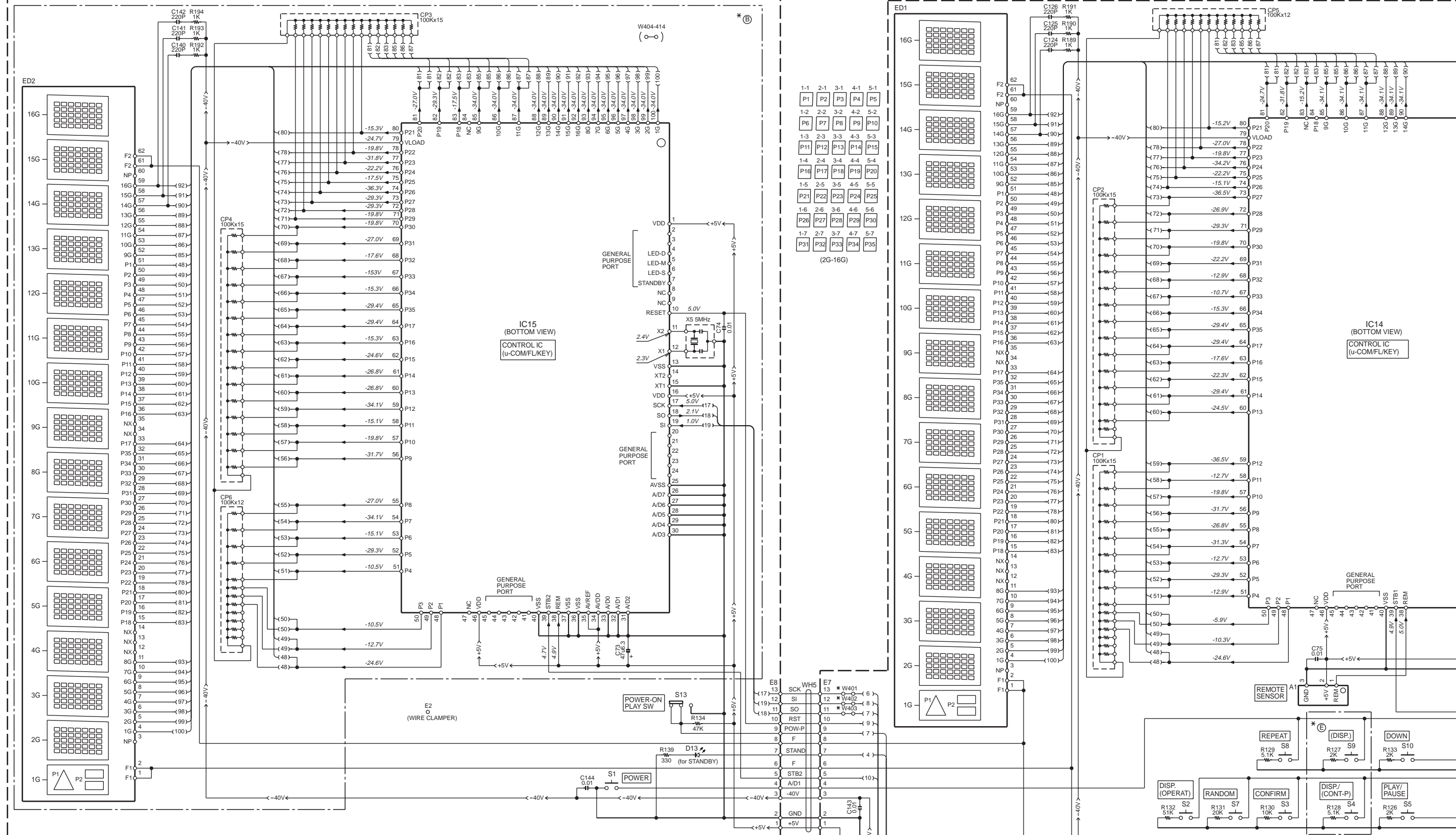

GND LINE  
 +B LINE  
 -B LINE

X32-A/B  
 -CN6

(X32-) (E/8)

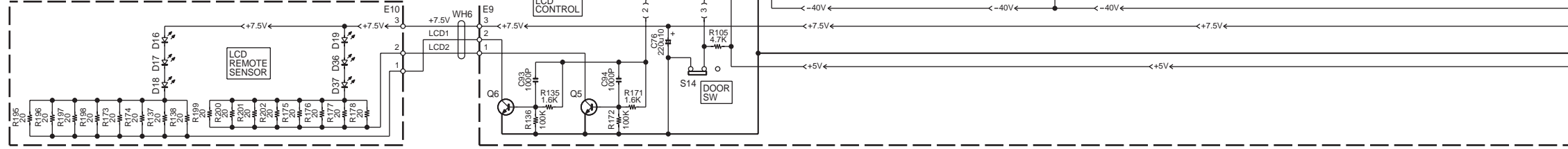

2  
3  
4  
5  
6  
7

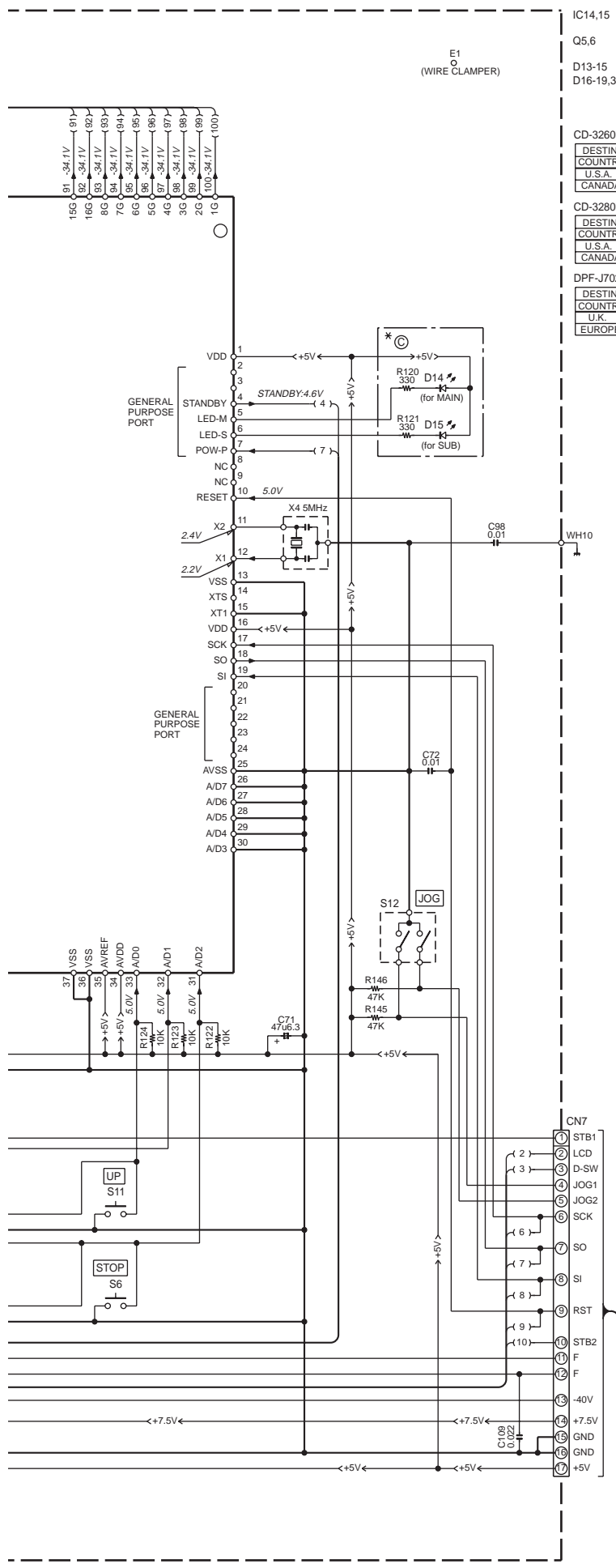

IC14,15 : uPD780204-038

Q5,6 : 2SC3246(J,K)

D13-15 : B30-2493-05

D16-19,36,37 : B30-2532-05

CD-3260M (X32-3500-12)

DESTINATION	COUNTRY	ABB.	UNIT No.	(B)(C)(E)	W401-403
U.S.A.	K1		0-12	NO	NO
CANADA	P2				

CD-3280M (X32-3500-13)

DESTINATION	COUNTRY	ABB.	UNIT No.	(B)(C)(E)	W401-403
U.S.A.	K		0-13	YES	YES
CANADA	P1				

DPF-J7020 (X32-3502-73)

DESTINATION	COUNTRY	ABB.	UNIT No.	(B)(C)(E)	W401-403
U.K.	T1		2-73	NO	NO
EUROPE	E1				

**CAUTION:** For continued safety, replace safety critical components only with manufacturer's recommended parts (refer to parts list). ⚠ indicates safety critical components. For continued protection against risk of fire, replace only with same type and rating fuse(s). To reduce the risk of electric shock, leakage-current or resistance measurements shall be carried out (exposed parts are acceptably insulated from the supply circuit) before the appliance is returned to the customer.

The DC voltage is an actual reading measured with a high impedance type voltmeter. The measurement value may vary depending on the measuring instruments used or on the product. Refer to the voltage during PLAY unless otherwise specified; The value shown in ( ) is the voltage measured at the moment of STOP.

# CD-3260M/3280M/DPF-J7020

## EXPLODED VIEW (MECHANISM)

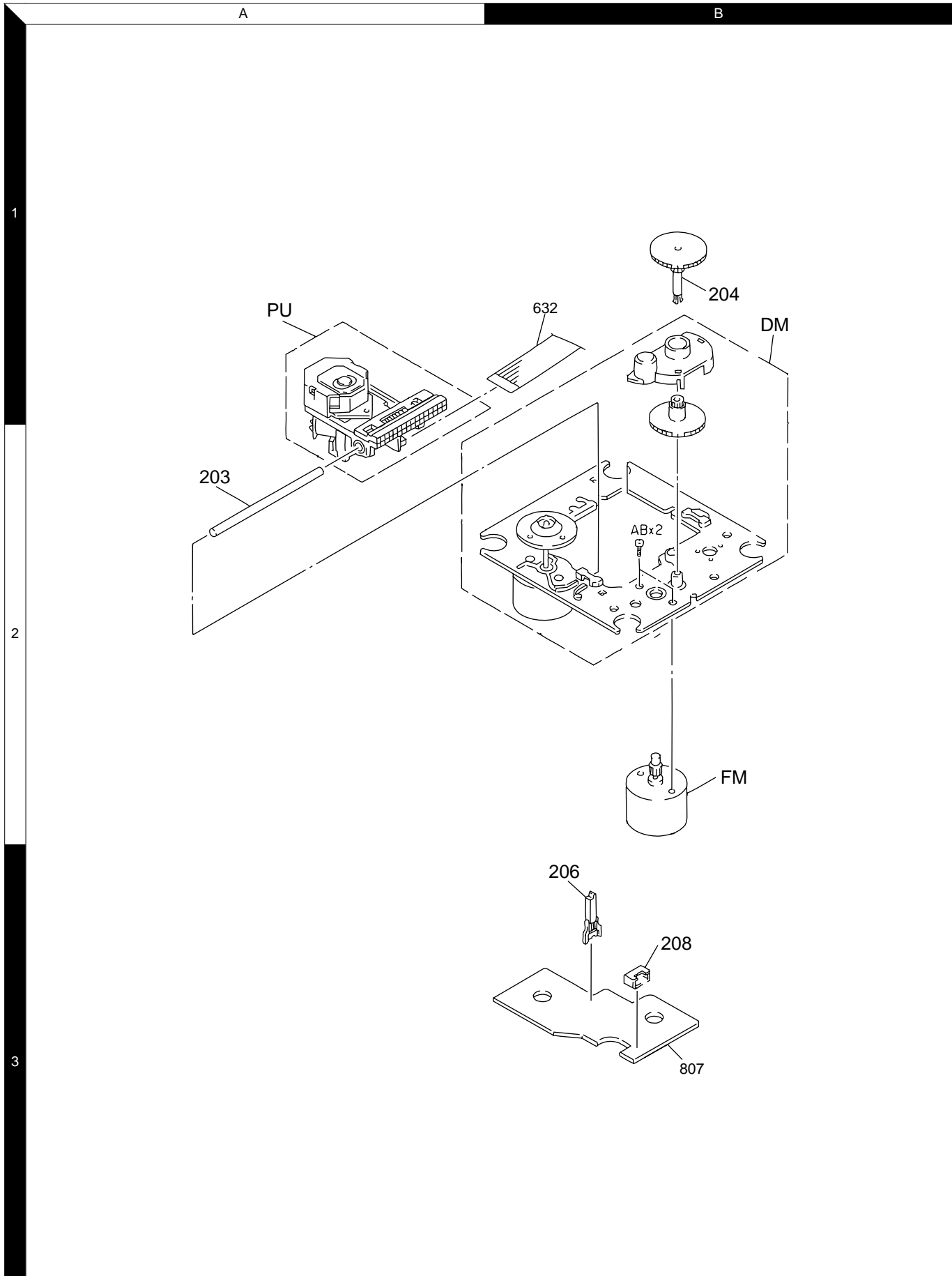

Parts with exploded numbers larger than 700 are not supplied.

C

D

E

The left screen parts and the right are one and the same if no ref number.

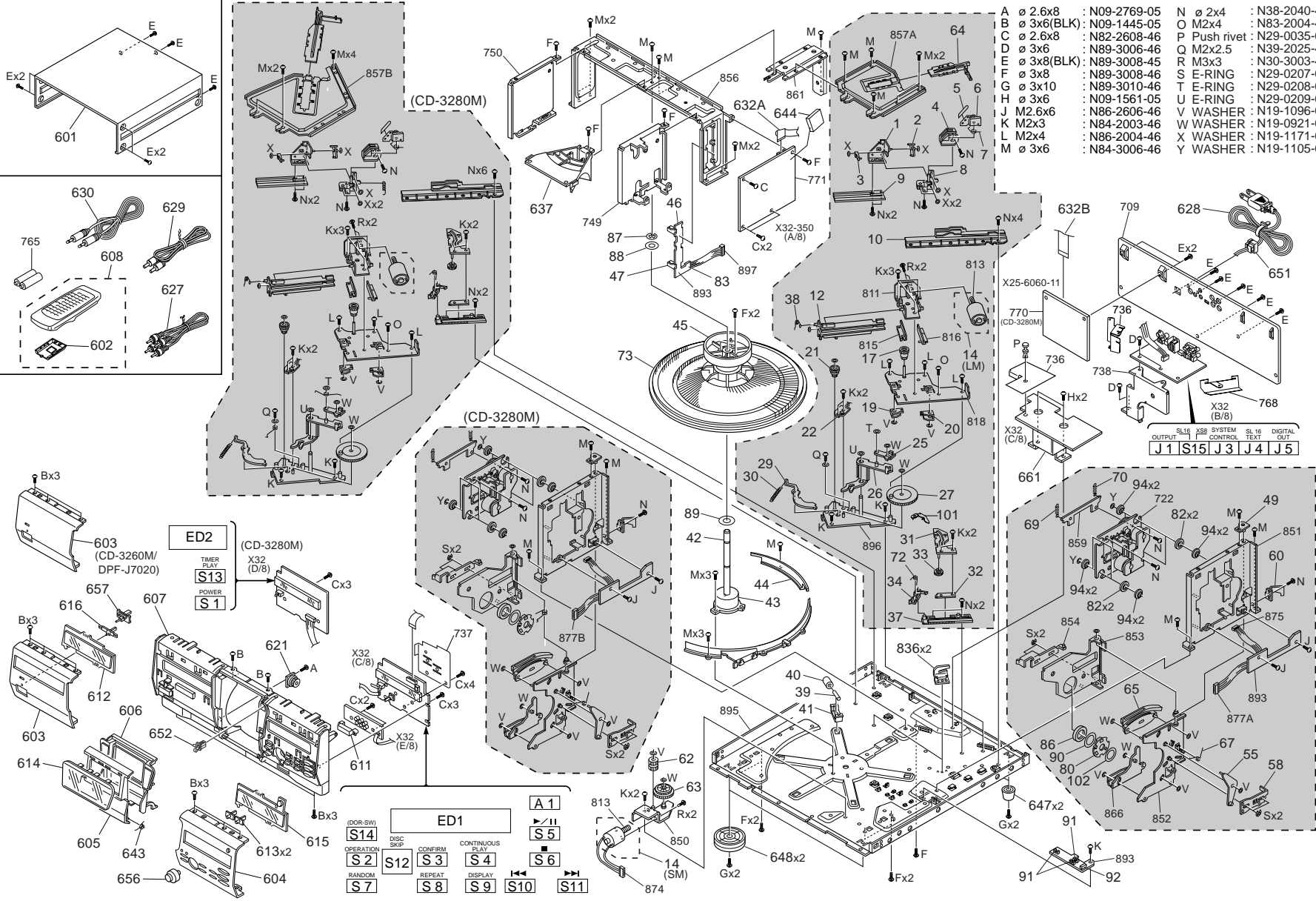

A	∅ 2.6x8	: N09-2769-05	N	∅ 2x4	: N38-2040-46
B	∅ 3x6(BLK)	: N09-1445-05	O	M2x4	: N83-2004-45
C	∅ 2.6x8	: N82-2608-46	P	Push rivet	: N29-0035-05
D	∅ 3x6	: N89-3006-46	Q	M2x2.5	: N39-2025-46
E	∅ 3x8(BLK)	: N89-3008-45	R	M3x3	: N30-3003-46
F	∅ 3x8	: N89-3008-46	S	E-RING	: N29-0207-04
G	∅ 3x10	: N89-3010-46	T	E-RING	: N29-0208-04
H	∅ 3x6	: N09-1561-05	U	E-RING	: N29-0209-04
J	M2.6x6	: N86-2606-46	V	WASHER	: N19-1096-04
K	M2x3	: N84-2003-46	W	WASHER	: N19-0921-04
L	M2x4	: N86-2004-46	X	WASHER	: N19-1171-04
M	∅ 3x6	: N84-3006-46	Y	WASHER	: N19-1105-04

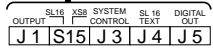
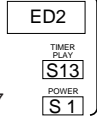

EXPLODED VIEW (UNIT)

CD-3260M/3280M/DPF-J7020

\* New Parts  
Parts without **Parts No.** are not supplied.  
Les articles non mentionnés dans le **Parts No.** ne sont pas fournis.  
Teile ohne **Parts No.** werden nicht geliefert.

①

Ref. No	Add-ress	New Parts	Parts No.	Description	Desti-nation	Re-marks
<b>CD-3260M/3280M/DPF-J7020</b>						
601	1C		A01-3536-08	METALLIC CABINET		
602	1C		A09-0374-08	CABINET		
603	2C	*	A21-3737-08	DRESSING PANEL L	KP1	
603	2C	*	A21-3738-08	DRESSING PANEL L	K1P2	
603	2C	*	A21-3739-08	DRESSING PANEL L	T1E1	
604	2C		A21-2000-18	DRESSING PANEL R	KP1	
604	2C		A21-3616-18	DRESSING PANEL R	E1	
604	2C		A21-3616-18	DRESSING PANEL R	K1P2T1	
605	2C		A29-0890-18	PANEL	KP1	
605	2C		A29-0897-18	PANEL	E1	
605	2C		A29-0897-18	PANEL	K1P2T1	
606	2C		A46-0305-08	REAR COVER		
607	2C	*	A60-1255-18	PANEL	KP1	
607	2C		A60-1259-18	PANEL	E1	
607	2C		A60-1259-18	PANEL	K1P2T1	
608	1C	*	A70-1256-08	REMOTE CONTROLLER ASSY	KP1	
608	1C		A70-1257-08	REMOTE CONTROLLER ASSY	E1	
608	1C		A70-1257-08	REMOTE CONTROLLER ASSY	K1P2T1	
611	2C		B10-2405-28	FRONT GLASS(REMOCON RECEIVE)		
612	2C		B10-2456-08	FRONT GLASS(L)	KP1	
613	2C		B12-0327-08	INDICATOR	KP1	
614	2C		B10-2395-08	FRONT GLASS(DOOR)		
615	2C		B10-2396-18	FRONT GLASS(R)		
616	2C		B12-0326-04	INDICATOR		
-			B46-0310-03	WARRANTY CARD	T1E1	
-			B46-0328-03	WARRANTY CARD	KK1	
-		*	B46-0346-00	QUESTIONNAIRE CARD	KK1	
-			B46-0347-03	WARRANTY CARD	P1P2	
-			B58-0964-13	CAUTION CARD (UL)	KK1	
-		*	B58-0965-13	CAUTION CARD (T,XtypePL)	T1	
-		*	B58-0966-13	CAUTION CARD (ELMtypePL)	E1	
-		*	B58-0967-03	CAUTION CARD (PtypePL)	P1P2	
-		*	B60-4085-08	INSTRUCTION MANUAL	KP1	
-			B60-4086-08	INSTRUCTION MANUAL	P1	
-		*	B60-4089-08	INSTRUCTION MANUAL	K1P2T1	
-		*	B60-4090-08	INSTRUCTION MANUAL	P2E1	
-		*	B60-4163-08	INSTRUCTION MANUAL	E1	
-		*	B60-4164-08	INSTRUCTION MANUAL	E1	
621	2C		D39-0335-18	DAMPER		
627	1C		E30-0505-05	AUDIO CORD		
628	1E		E30-2788-05	AC POWER CORD	E1	
628	1E		E30-2791-05	AC POWER CORD	T1	
628	1E		E30-2883-05	AC POWER CORD	KP1K1	
628	1E		E30-2883-05	AC POWER CORD	P2	
629	1E		E30-2816-05	CORD WITH PLUG,SYSTEM(3.5mm)		
630	1E		E30-2861-05	CORD WITH PLUG,CD TEXT(2.5mm)		
632A	1D		E35-2325-08	FLAT CABLE MAIN-PIC 16P		
632B	1E		E35-1949-08	FLAT CABLE SUB-PIC 16P	KP1	
637	1D		F07-1613-08	COVER PANEL-DISC		
643	2C		G01-4026-18	TORSION COIL SPRING		
644	1D		G13-0595-08	CUSHION		

L : Scandinavia K : USA P : Canada R : Mexico C : China I : Malaysia  
Y : PX(Far East, Hawaii) T : Europe E : Europe G : Germany V : China (Shanghai)  
Y : AAFES(Europe) X : Australia Q : Russia H : Korea M : Other Areas Δ indicates safety critical components.

\* New Parts  
Parts without **Parts No.** are not supplied.  
Les articles non mentionnés dans le **Parts No.** ne sont pas fournis.  
Teile ohne **Parts No.** werden nicht geliefert.

②

Ref. No	Add-ress	New Parts	Parts No.	Description	Desti-nation	Re-marks
-			H10-7397-18	POLYSTYRENE FOAMED FIXTURE		
-			H10-7398-18	POLYSTYRENE FOAMED FIXTURE		
-			H12-2401-08	PACKING FIXTURE		
-			H21-0353-18	PROTECTION SHEET		
-			H25-0232-04	PROTECTION BAG (235X350X0.03)	KP1K1	
-			H25-0232-04	PROTECTION BAG (235X350X0.03)	P2E1	
-			H25-0651-04	PROTECTION BAG (0232 PRINT)	T1	
-			H25-0692-04	PROTECTION BAG		
-		*	H30-0607-08	ADHESIVE DOUBLE-COATED TAPE		
-		*	H50-3183-08	ITEM CARTON CASE	KP1	
-		*	H50-3185-08	ITEM CARTON CASE	K1P2	
-		*	H50-3186-08	ITEM CARTON CASE	T1E1	
647	2E		J02-1416-08	FOOT (REAR) (1-8200-2103-0)		
648	2D		J02-1414-08	FOOT (FRONT) (1-8200-2101-0)		
651	1E		J42-0083-05	POWER CORD BUSHING		
652	2C		J52-0039-05	PUSH LATCH		
-			J61-0098-05	WIRE BAND		
656	2C		K29-6803-08	KNOB		
657	2C	*	K29-6884-18	KNOB		
661	2E		L07-2446-08	POWER TRANSFORMER	KP1	
661	2E		L07-2449-08	POWER TRANSFORMER	K1P2	
661	2E		L07-2451-08	POWER TRANSFORMER	T1E1	
<b>SUB-CIRCUIT UNIT (X25-6060-11)</b>						
C1			CE04KW1A101M	ELECTRO	100UF	10WV
C2			CE04KW0J221M	ELECTRO	220UF	6.3WV
C3			CE04KW1A470M	ELECTRO	47UF	10WV
C4			CC45FSL1H270JN	CERAMIC	27PF	J
C5			CE04KW0J221M	ELECTRO	220UF	6.3WV
C7			CE04KW1A470M	ELECTRO	47UF	10WV
C9			CK45FB1H471KMM	CERAMIC	470PF	K
C10			CC45FSL1H221JN	CERAMIC	220PF	J
C11			CF92FV1H104J	MF-C	0.10UF	J
C12			CF92FV1H474J	MF-C	0.47UF	J
C13			CQ93FMG1H103J	MYLAR	0.010UF	J
C14			CK45FB1H332KMM	CERAMIC	3300PF	K
C15			CK45FB1H152KMM	CERAMIC	1500PF	K
C16			CQ93FMG1H473J	MYLAR	0.047UF	J
C17			CK45FF1H103ZMM	CERAMIC	0.010UF	Z
C18			CE04KW1A101M	ELECTRO	100UF	10WV
C21 ,22			CK45FF1H103ZMM	CERAMIC	0.010UF	Z
C23			CE04KW1A221M	ELECTRO	220UF	10WV
C24			CQ93FMG1H333J	MYLAR	0.033UF	J
C25 ,26			CE04KW0J331M	ELECTRO	330UF	6.3WV
C27 ,28			CC45FSL1H151JN	CERAMIC	150PF	J
C29 ,30			CQ93FMG1H821J	MYLAR	820PF	J
C31			CE04KW1A470M	ELECTRO	47UF	10WV
C32			CK45FF1H103ZMM	CERAMIC	0.010UF	Z
C33			CF92FV1H104J	MF-C	0.10UF	J
C37 ,38			CE04KW1A220M	ELECTRO	22UF	10WV
CN1			E40-4997-05	FLAT CABLE CONNECTOR		
CN2			E40-4979-05	PIN ASSY		
CN3			E40-3268-05	PIN ASSY		
CN4			E40-3256-05	PIN ASSY		

L : Scandinavia K : USA P : Canada R : Mexico C : China I : Malaysia  
Y : PX(Far East, Hawaii) T : Europe E : Europe G : Germany V : China (Shanghai)  
Y : AAFES(Europe) X : Australia Q : Russia H : Korea M : Other Areas Δ indicates safety critical components.

\* New Parts

Parts without **Parts No.** are not supplied.  
Les articles non mentionnés dans le **Parts No.** ne sont pas fournis.  
Teile ohne **Parts No.** werden nicht geliefert.

③

Ref. No	Address	New Parts	Parts No.	Description	Destination	Remarks
P1 ,2			J21-5845-04	MOUNTING HARDWARE	KP1	
L1			L40-1001-17	SMALL FIXED INDUCTOR(10UH,K)	KP1	
X1			L78-0299-05	RESONATOR (16.93M)	KP1	
X2			L78-0605-05	RESONATOR (8.38MHZ)	KP1	
CP1			R90-0875-05	MULTI-COMP 100KX15	KP1	
VR1			R12-3101-05	TRIMMING POT.	KP1	
D1 ,2			HSS104	DIODE	KP1	
D1 ,2			1SS133	DIODE	KP1	
IC1			CXA1571M	ANALOGUE IC	KP1	
IC2			CXD2587Q	MOS-IC	KP1	
IC3		*	UPD780023GC512	MI-COM IC	KP1	
IC4			TA8409S	MOS-IC	KP1	
IC5			BA5979S	ANALOGUE IC	KP1	
Q1			ZSA954(L,K)	TRANSISTOR	KP1	
<b>CD PLAYER UNIT (X32-350X-XX)</b>						
D13			B30-2493-05	LED(RED)	E1	
D13			B30-2493-05	LED(RED)	K1P2T1	
D13 -15			B30-2493-05	LED(RED)	KP1	
D16 -19			B30-2532-05	LED(INFRARED)		
D36 ,37			B30-2532-05	LED(INFRARED)		
C1			C90-3214-05	ELECTRO 100UF 6.3WV		
C2			C90-3215-05	ELECTRO 220UF 6.3WV		
C3			C90-3203-05	ELECTRO 47UF 4WV		
C4			CC73FSL1H270J	CHIP C 27PF J		
C5			CE04KW0J221M	ELECTRO 220UF 6.3WV		
C6			CK73FB1H223K	CHIP C 0.022UF K		
C7			C90-3203-05	ELECTRO 47UF 4WV		
C8			CK73FB1E104K	CHIP C 0.10UF K		
C9			CC73FSL1H471J	CHIP C 470PF J		
C10			CC73FSL1H221J	CHIP C 220PF J		
C11			CK73FB1E104K	CHIP C 0.10UF K		
C12			CK73FB1C474K	CHIP C 0.47UF K		
C13			CK73FB1H103K	CHIP C 0.010UF K		
C14			CK73FB1H333K	CHIP C 3300PF K		
C15			CK73FB1H152K	CHIP C 1500PF K		
C16			CK73FB1H473K	CHIP C 0.047UF K		
C17			C90-3223-05	ELECTRO 220UF 10WV		
C18			C90-3214-05	ELECTRO 100UF 6.3WV		
C19 ,20			CC73FCH1H070D	CHIP C 7.0PF D		
C21			CK73FB1H103K	CHIP C 0.010UF K		
C22			CK73FB1E104K	CHIP C 0.10UF K		
C23			CK73FB1H103K	CHIP C 0.010UF K		
C24			CK73FB1H333K	CHIP C 0.033UF K		
C25 ,26			CE04KW0J331M	ELECTRO 330UF 6.3WV		
C27 ,28			CC73FSL1H151J	CHIP C 150PF J		
C29 ,30			CC73FSL1H821J	CHIP C 820PF J		
C31 -34			CE04KW1A470M	ELECTRO 47UF 10WV	KP1	
C31 ,32			CE04KW1A470M	ELECTRO 47UF 10WV	E1	
C31 ,32			CE04KW1A470M	ELECTRO 47UF 10WV	K1P2T1	
C35 -38			CC73FSL1H821J	CHIP C 820PF J	KP1	
C35 ,36			CC73FSL1H821J	CHIP C 820PF J	E1	
C35 ,36			CC73FSL1H821J	CHIP C 820PF J	K1P2T1	
C39			CK73FB1H103K	CHIP C 0.010UF K	E1	

L : Scandinavia K : USA P : Canada R : Mexico C : China I : Malaysia  
Y : PX(Far East, Hawaii) T : Europe E : Europe G : Germany V : China (Shanghai)  
Y : AAFES(Europe) X : Australia Q : Russia H : Korea M : Other Areas  $\Delta$  indicates safety critical components.

\* New Parts

Parts without **Parts No.** are not supplied.  
Les articles non mentionnés dans le **Parts No.** ne sont pas fournis.  
Teile ohne **Parts No.** werden nicht geliefert.

④

Ref. No	Address	New Parts	Parts No.	Description	Destination	Remarks
C39			CK73FB1H103K	CHIP C 0.010UF K		K1P2T1
C39 -43			CK73FB1H103K	CHIP C 0.010UF K		KP1
C41			CK73FB1H103K	CHIP C 0.010UF K		E1
C41			CK73FB1H103K	CHIP C 0.010UF K		K1P2T1
C43			CK73FB1H103K	CHIP C 0.010UF K		E1
C43			CK73FB1H103K	CHIP C 0.010UF K		K1P2T1
C44 -46			CK45FF1H103Z	CERAMIC 0.010UF Z		
C47			CE04KW1E332M	ELECTRO 3300UF 25WV		
C48			CK73FB1H102K	CHIP C 1000PF K		
C49			CE04KW1A332M	ELECTRO 3300UF 10WV		
C50			CE04KW2A470M	ELECTRO 47UF 100WV		
C51			CK73FB1H103K	CHIP C 0.010UF K		
C52			CE04KW1H221M	ELECTRO 220UF 50WV		
C53			CE04KW0J331M	ELECTRO 330UF 6.3WV		
C54			CE04KW1H100M	ELECTRO 10UF 50WV		
C55			CE04KW1H010M	ELECTRO 1.0UF 50WV		
C56			CE04KW1A101M	ELECTRO 100UF 10WV		
C57			C90-3542-05	SUPER-C 1.0F 5.5WV		
C58			CE04KW1A470M	ELECTRO 47UF 10WV		
C59			CK73FB1H103K	CHIP C 0.010UF K		
C60 ,61			CC73FSL1H221J	CHIP C 220PF J		
C62			CK73FB1H103K	CHIP C 0.010UF K		
C63 -65			CC73FSL1H101J	CHIP C 100PF J		
C66			CK73FB1H103K	CHIP C 0.010UF K		
C67			CE04KW1A470M	ELECTRO 47UF 10WV		
C68			C90-3212-05	ELECTRO 47UF 6.3WV		
C69 ,70			CK73FB1E104K	CHIP C 0.10UF K		
C71			C90-3212-05	ELECTRO 47UF 6.3WV		
C72			CK73FB1H103K	CHIP C 0.010UF K		
C73			C90-3212-05	ELECTRO 47UF 6.3WV		KP1
C74 ,75			CK73FB1H103K	CHIP C 0.010UF K		KP1
C75			CK73FB1H103K	CHIP C 0.010UF K		E1
C75			CK73FB1H103K	CHIP C 0.010UF K		K1P2T1
C76			C90-3223-05	ELECTRO 220UF 10WV		
C81			CK73FB1C224K	CHIP C 0.22UF K		KP1K1
C81			CK73FB1C224K	CHIP C 0.22UF K		P2
C82			CK73FF1C105Z	CHIP C 1.0UF Z		KP1K1
C82			CK73FF1C105Z	CHIP C 1.0UF Z		P2
C83			CK73FB1E104K	CHIP C 0.10UF K		T1E1
C84			CK73FB1H103K	CHIP C 0.010UF K		
C85 -92			CC73FSL1H101J	CHIP C 100PF J		KP1
C85 ,86			CC73FSL1H101J	CHIP C 100PF J		E1
C85 ,86			CC73FSL1H101J	CHIP C 100PF J		K1P2T1
C89 ,90			CC73FSL1H101J	CHIP C 100PF J		E1
C89 ,90			CC73FSL1H101J	CHIP C 100PF J		K1P2T1
C93 ,94			CK73FB1H102K	CHIP C 1000PF K		
C98			CK73FB1H103K	CHIP C 0.010UF K		
C99			CK73FB1E104K	CHIP C 0.10UF K		
C101-106			CE04KW1C220M	ELECTRO 22UF 16WV		KP1
C101 ,102			CE04KW1C220M	ELECTRO 22UF 16WV		E1
C101 ,102			CE04KW1C220M	ELECTRO 22UF 16WV		K1P2T1
C107 ,108			CK73FB1H103K	CHIP C 0.010UF K		KP1
C109			CK73FB1H223K	CHIP C 0.022UF K		
C124-126			CC73FSL1H221J	CHIP C 220PF J		
C140-142			CC73FSL1H221J	CHIP C 220PF J		KP1

L : Scandinavia K : USA P : Canada R : Mexico C : China I : Malaysia  
Y : PX(Far East, Hawaii) T : Europe E : Europe G : Germany V : China (Shanghai)  
Y : AAFES(Europe) X : Australia Q : Russia H : Korea M : Other Areas  $\Delta$  indicates safety critical components.

PARTS LIST

CD-3260M/3280M/DPF-J7020

\* New Parts  
 Parts without **Parts No.** are not supplied.  
 Les articles non mentionnes dans le **Parts No.** ne sont pas fournis.  
 Teile ohne **Parts No.** werden nicht geliefert.

5

Ref. No	Add-ress	New Parts	Parts No.	Description	Desti-nation	Re-marks
C143			CK73FB1H103K	CHIP C 0.010UF K	E1	
C143			CK73FB1H103K	CHIP C 0.010UF K	K1P2T1	
C143,144			CK73FB1H103K	CHIP C 0.010UF K	KP1	
C151-154			CE04KW1C220M	ELECTRO 22UF 16VV	KP1	
C151,152			CE04KW1C220M	ELECTRO 22UF 16VV	E1	
C151,152			CE04KW1C220M	ELECTRO 22UF 16VV	K1P2T1	
C155			CK73FB1C474K	CHIP C 0.47UF K		
C156			C90-3216-05	ELECTRO 330UF 6.3VV		
C157			CC73FSL1H101J	CHIP C 100PF J		
C158			CK73EB1H103K	CHIP C 0.010UF K	K1P2	
CN1			E40-4997-05	FLAT CABLE CONNECTOR		
CN2			E40-4979-05	PIN ASSY		
CN3			E40-3268-05	PIN ASSY		
CN4			E40-3266-05	PIN ASSY		
CN5			E40-3260-05	PIN ASSY		
CN6,7			E40-4942-05	FLAT CABLE CONNECTOR		
CN9			E40-4245-05	PIN ASSY		
CN11,12			E40-3249-05	PIN ASSY		
CN13,14			E40-3258-05	PIN ASSY		
CN15			E40-3270-05	PIN ASSY	KP1	
CN16			E40-4296-05	FLAT CABLE CONNECTOR	KP1	
J1			E63-0120-05	PHONO JACK	KP1	
J1			E63-1078-05	PHONO JACK	E1	
J1			E63-1078-05	PHONO JACK	K1P2T1	
J3			E11-0293-05	MINIATURE PHONE JACK(2P)		
J4			E11-0360-05	MINIATURE PHONE JACK(BLK,2.5 S		
J5			E63-1079-05	PHONO JACK	KP1K1	
J5			E63-1079-05	PHONO JACK	P2	
-			J19-5789-04	HOLDER		
E1 ,3			J11-0809-05	WIRE CLAMPER	KP1	
E1 ,2			J11-0809-05	WIRE CLAMPER	E1	
E1 ,2			J11-0809-05	WIRE CLAMPER	K1P2T1	
L1			L40-1001-17	SMALL FIXED INDUCTOR(10UH,K)		
L2 ,3			L79-1216-05	LINE FILTER		
L4			L33-0558-05	CHOKE COIL		
L5			L40-1001-17	SMALL FIXED INDUCTOR(10UH,K)		
X1			L77-2226-05	CRYSTAL RESONATOR(16.9344MHZ)		
X2			L78-0615-05	RESONATOR (12.5MHZ)		
X3			L78-0674-05	RESONATOR (3.64MHZ)		
X4			L78-0284-05	RESONATOR (5MHZ)	E1	
X4			L78-0284-05	RESONATOR (5MHZ)	K1P2T1	
X4 ,5			L78-0284-05	RESONATOR (5MHZ)	KP1	
CP1 ,4			R90-0875-05	MULTI-COMP 100KX15	KP1	
CP1 ,2			R90-0875-05	MULTI-COMP 100KX15	E1	
CP1 ,2			R90-0875-05	MULTI-COMP 100KX15	K1P2T1	
CP5			R90-0479-05	MULTI-COMP 100KX12	E1	
CP5			R90-0479-05	MULTI-COMP 100KX12	K1P2T1	
CP5 ,6			R90-0479-05	MULTI-COMP 100KX12	KP1	
R1			RK73FB2A224J	CHIP R 220K J 1/10W		
R2 ,5			RK73FB2A683J	CHIP R 68K J 1/10W		
R6			RK73FB2A224J	CHIP R 220K J 1/10W		
R7			RK73FB2A100J	CHIP R 10 J 1/10W		

L : Scandinavia K : USA P : Canada R : Mexico C : China I : Malaysia  
 Y : PX(Far East, Hawaii) T : Europe E : Europe G : Germany V : China (Shanghai)  
 Y : AAFES(Europe) X : Australia Q : Russia H : Korea M : Other Areas Δ indicates safety critical components.

\* New Parts  
 Parts without **Parts No.** are not supplied.  
 Les articles non mentionnes dans le **Parts No.** ne sont pas fournis.  
 Teile ohne **Parts No.** werden nicht geliefert.

6

Ref. No	Add-ress	New Parts	Parts No.	Description	Desti-nation	Re-marks
R8			RK73FB2A273J	CHIP R 27K J 1/10W		
R9			RK73FB2A153J	CHIP R 15K J 1/10W		
R10 ,11			RK73FB2A101J	CHIP R 100 J 1/10W		
R12			RK73FB2A203J	CHIP R 20K J 1/10W		
R13			RK73FB2A562J	CHIP R 5.6K J 1/10W		
R14			RK73FB2A183J	CHIP R 18K J 1/10W		
R15 ,16			RK73FB2A103J	CHIP R 10K J 1/10W		
R17 ,18			RK73FB2A153J	CHIP R 15K J 1/10W		
R19			RK73FB2A104J	CHIP R 100K J 1/10W		
R20			RK73FB2A333J	CHIP R 33K J 1/10W		
R21			RK73FB2A104J	CHIP R 100K J 1/10W		
R22			RK73FB2A105J	CHIP R 1.0M J 1/10W		
R23			RK73FB2A103J	CHIP R 10K J 1/10W		
R24 ,25			RK73FB2A332J	CHIP R 3.3K J 1/10W		
R26			RK73FB2A331J	CHIP R 330 J 1/10W		
R27			RK73FB2A105J	CHIP R 1.0M J 1/10W		
R28			RK73FB2A473J	CHIP R 47K J 1/10W		
R29			RK73FB2A154J	CHIP R 150K J 1/10W		
R30			RK73FB2A104J	CHIP R 100K J 1/10W		
R31			RK73FB2A102J	CHIP R 1.0K J 1/10W		
R32 ,33			RK73FB2A472J	CHIP R 4.7K J 1/10W		
R34			RK73FB2A104J	CHIP R 100K J 1/10W		
R35			RK73FB2A153J	CHIP R 15K J 1/10W		
R36			RK73FB2A103J	CHIP R 10K J 1/10W		
R38			RK73FB2A200J	CHIP R 20 J 1/10W		
R39 ,40			RK73FB2A133J	CHIP R 13K J 1/10W		
R41 ,42			RK73FB2A153J	CHIP R 15K J 1/10W		
R43 ,44			RK73FB2A103J	CHIP R 10K J 1/10W		
R45 ,46			RK73FB2A332J	CHIP R 3.3K J 1/10W	KP1	
R45 ,48			RK73FB2A332J	CHIP R 3.3K J 1/10W	E1	
R45 ,46			RK73FB2A332J	CHIP R 3.3K J 1/10W	K1P2T1	
R49 ,52			RK73FB2A822J	CHIP R 8.2K J 1/10W	KP1	
R49 ,50			RK73FB2A822J	CHIP R 8.2K J 1/10W	E1	
R49 ,50			RK73FB2A822J	CHIP R 8.2K J 1/10W	K1P2T1	
R53 ,56			R92-1876-05	METAL 10.5K F 1/10W	KP1	
R53 ,54			R92-1876-05	METAL 10.5K F 1/10W	E1	
R53 ,54			R92-1876-05	METAL 10.5K F 1/10W	K1P2T1	
R57 ,60			R92-1868-05	METAL 4.3K F 1/10W	KP1	
R57 ,58			R92-1868-05	METAL 4.3K F 1/10W	E1	
R57 ,58			R92-1868-05	METAL 4.3K F 1/10W	K1P2T1	
R61 ,64			RK73FB2A104J	CHIP R 100K J 1/10W	KP1	
R61 ,62			RK73FB2A104J	CHIP R 100K J 1/10W	E1	
R61 ,62			RK73FB2A104J	CHIP R 100K J 1/10W	K1P2T1	
R65 ,68			RK73FB2A331J	CHIP R 330 J 1/10W	KP1	
R65 ,66			RK73FB2A331J	CHIP R 330 J 1/10W	E1	
R65 ,66			RK73FB2A331J	CHIP R 330 J 1/10W	K1P2T1	
R69 ,72			RK73FB2A102J	CHIP R 1.0K J 1/10W	KP1	
R69 ,70			RK73FB2A102J	CHIP R 1.0K J 1/10W	E1	
R69 ,70			RK73FB2A102J	CHIP R 1.0K J 1/10W	K1P2T1	
R73 ,76			RK73FB2A223J	CHIP R 22K J 1/10W	KP1	
R73 ,74			RK73FB2A223J	CHIP R 22K J 1/10W	E1	
R73 ,74			RK73FB2A223J	CHIP R 22K J 1/10W	K1P2T1	
R77 ,80			RK73FB2A221J	CHIP R 220 J 1/10W	KP1	
R77 ,78			RK73FB2A221J	CHIP R 220 J 1/10W	E1	
R77 ,78			RK73FB2A221J	CHIP R 220 J 1/10W	K1P2T1	

L : Scandinavia K : USA P : Canada R : Mexico C : China I : Malaysia  
 Y : PX(Far East, Hawaii) T : Europe E : Europe G : Germany V : China (Shanghai)  
 Y : AAFES(Europe) X : Australia Q : Russia H : Korea M : Other Areas Δ indicates safety critical components.



\* New Parts

Parts without **Parts No.** are not supplied.  
Les articles non mentionnés dans le **Parts No.** ne sont pas fournis.  
Teile ohne **Parts No.** werden nicht geliefert.

7

Ref. No	Address	New Parts	Parts No.	Description	Quantity	Unit	Lead Time	Destination	Remarks
R81			RK73FB2A222J	CHIP R	2.2K	J	1/10W	E1	
R81			RK73FB2A222J	CHIP R	2.2K	J	1/10W	K1P2T1	
R81,82			RK73FB2A222J	CHIP R	2.2K	J	1/10W	KP1	
R83			RK73FB2A361J	CHIP R	360	J	1/10W		
R84			RS14KB3A271J	FL-PROOF RS	270	J	1W		
R85			RK73FB2A103J	CHIP R	10K	J	1/10W		
R86			RK73FB2A153J	CHIP R	15K	J	1/10W		
R87,88			RK73FB2A101J	CHIP R	100	J	1/10W		
R89			RK73FB2A103J	CHIP R	10K	J	1/10W		
R90,91			RK73FB2A472J	CHIP R	4.7K	J	1/10W		
R92			RK73FB2A2R2J	CHIP R	2.2	J	1/10W		
R93			RK73FB2A271J	CHIP R	270	J	1/10W		
R94			RK73FB2A164J	CHIP R	160K	J	1/10W		
R95			RK73FB2A224J	CHIP R	220K	J	1/10W		
R96-99			RK73FB2A103J	CHIP R	10K	J	1/10W		
R100,101			RK73FB2A472J	CHIP R	4.7K	J	1/10W		
R102			RK73FB2A473J	CHIP R	47K	J	1/10W		
R103			RK73FB2A103J	CHIP R	10K	J	1/10W		
R104			RK73FB2A203J	CHIP R	20K	J	1/10W	E1	
R104			RK73FB2A203J	CHIP R	20K	J	1/10W	K1P2T1	
R105-107			RK73FB2A472J	CHIP R	4.7K	J	1/10W		
R108			RK73FB2A473J	CHIP R	47K	J	1/10W		
R109			RK73FB2A332J	CHIP R	3.3K	J	1/10W		
R110,111			RK73FB2A331J	CHIP R	330	J	1/10W		
R112-115			RK73FB2A104J	CHIP R	100K	J	1/10W		
R116			RK73FB2A473J	CHIP R	47K	J	1/10W		
R117			RK73FB2A182J	CHIP R	1.8K	J	1/10W		
R118			RK73FB2A103J	CHIP R	10K	J	1/10W		
R119			RK73FB2A102J	CHIP R	1.0K	J	1/10W		
R120,121			RK73FB2A331J	CHIP R	330	J	1/10W	KP1	
R122-124			RK73FB2A103J	CHIP R	10K	J	1/10W		
R126			RK73FB2A202J	CHIP R	2.0K	J	1/10W	E1	
R126,127			RK73FB2A202J	CHIP R	2.0K	J	1/10W	K1P2T1	
R128,129			RK73FB2A512J	CHIP R	5.1K	J	1/10W	KP1	
R129			RK73FB2A512J	CHIP R	5.1K	J	1/10W	E1	
R129			RK73FB2A512J	CHIP R	5.1K	J	1/10W	K1P2T1	
R130			RK73FB2A103J	CHIP R	10K	J	1/10W		
R131			RK73FB2A203J	CHIP R	20K	J	1/10W		
R132			RK73FB2A513J	CHIP R	51K	J	1/10W		
R133			RK73FB2A202J	CHIP R	2.0K	J	1/10W		
R134			RK73FB2A473J	CHIP R	47K	J	1/10W		
R135			RK73FB2A162J	CHIP R	1.6K	J	1/10W		
R136			RK73FB2A104J	CHIP R	100K	J	1/10W		
R137,138			RK73FB2A200J	CHIP R	20	J	1/10W		
R139			RK73FB2A331J	CHIP R	330	J	1/10W		
R140-143			RK73FB2A473J	CHIP R	47K	J	1/10W		
R144			RK73FB2A472J	CHIP R	4.7K	J	1/10W		
R145,146			RK73FB2A473J	CHIP R	47K	J	1/10W		
R147			RK73FB2A103J	CHIP R	10K	J	1/10W		
R148			RK73FB2A181J	CHIP R	180	J	1/10W	KP1K1	
R148			RK73FB2A181J	CHIP R	180	J	1/10W	P2	
R149			RK73FB2A750J	CHIP R	75	J	1/10W	KP1	
R150			RK73FB2A220J	CHIP R	22	J	1/10W	KP1K1	
R150			RK73FB2A220J	CHIP R	22	J	1/10W	P2	

L : Scandinavia K : USA P : Canada R : Mexico C : China I : Malaysia  
 Y : PX(Far East, Hawaii) T : Europe E : Europe G : Germany V : China (Shanghai)  
 Y : AAFES(Europe) X : Australia Q : Russia H : Korea M : Other Areas Δ indicates safety critical components.

\* New Parts

Parts without **Parts No.** are not supplied.  
Les articles non mentionnés dans le **Parts No.** ne sont pas fournis.  
Teile ohne **Parts No.** werden nicht geliefert.

8

Ref. No	Address	New Parts	Parts No.	Description	Quantity	Unit	Lead Time	Destination	Remarks
R151-154			RK73FB2A101J	CHIP R	100	J	1/10W		KP1
R155-168			RK73FB2A103J	CHIP R	10K	J	1/10W		KP1
R155,156			RK73FB2A103J	CHIP R	10K	J	1/10W		E1
R155,156			RK73FB2A103J	CHIP R	10K	J	1/10W		K1P2T1
R163,164			RK73FB2A103J	CHIP R	10K	J	1/10W		E1
R163,164			RK73FB2A103J	CHIP R	10K	J	1/10W		K1P2T1
R169,170			RK73FB2A223J	CHIP R	22K	J	1/10W		KP1
R171			RK73FB2A162J	CHIP R	1.6K	J	1/10W		
R172			RK73FB2A104J	CHIP R	100K	J	1/10W		
R173-178			RK73FB2A200J	CHIP R	20	J	1/10W		
R181-184			RK73FB2A103J	CHIP R	10K	J	1/10W		E1
R181-184			RK73FB2A103J	CHIP R	10K	J	1/10W		K1P2T1
R181-188			RK73FB2A103J	CHIP R	10K	J	1/10W		KP1
R189-191			RK73FB2A102J	CHIP R	1.0K	J	1/10W		E1
R189-191			RK73FB2A102J	CHIP R	1.0K	J	1/10W		K1P2T1
R189-194			RK73FB2A102J	CHIP R	1.0K	J	1/10W		KP1
R195-203			RK73FB2A200J	CHIP R	20	J	1/10W		
R204			RK73FB2A681J	CHIP R	680	J	1/10W		
R205			RK73FB2A102J	CHIP R	1.0K	J	1/10W		
R207-210			RK73FB2A331J	CHIP R	330	J	1/10W		KP1
R207,208			RK73FB2A331J	CHIP R	330	J	1/10W		E1
R207,208			RK73FB2A750J	CHIP R	75	J	1/10W		K1P2T1
R211			R12-3101-05	TRIMMING POT.					
VR1									
S1 -11			S70-0031-05	TACT SWITCH					KP1
S1 -3			S70-0031-05	TACT SWITCH					E1
S1 -3			S70-0031-05	TACT SWITCH					K1P2T1
S5 -8			S70-0031-05	TACT SWITCH					E1
S5 -8			S70-0031-05	TACT SWITCH					K1P2T1
S10,11			S70-0031-05	TACT SWITCH					E1
S10,11			S70-0031-05	TACT SWITCH					K1P2T1
S13			S62-0070-05	SLIDE SWITCH					
S14			S64-0034-05	LEVER SWITCH					
S15			S31-2132-05	SLIDE SWITCH					
S12			T99-0596-05	ROTARY ENCODER					
D1 -11			HSS104A	DIODE					
D1 -11			1SS133	DIODE					
Δ D20			D3SBA20F03	DIODE					
Δ D20			RBV-402LFA	DIODE					
D21			HZS7.5S(B2)	ZENER DIODE					
D21			RD7.5JS(B2)	ZENER DIODE					
D22			DLM10C	DIODE					
D23			HSS104A	DIODE					
D23			1SS133	DIODE					
Δ D24,25			S5688B	DIODE					
Δ D24,25			1SR139-400	DIODE					
D26			HZS16N(B2)	ZENER DIODE					
D26			RD16ES(B2)	ZENER DIODE					
D27			HZS20N(B)	ZENER DIODE					
D27			RD20ES(B)	ZENER DIODE					
D28			HZS11N(B2)	ZENER DIODE					
D28			RD11ES(B2)	ZENER DIODE					
D29 -35			HSS104A	DIODE					
D29 -35			1SS133	DIODE					

L : Scandinavia K : USA P : Canada R : Mexico C : China I : Malaysia  
 Y : PX(Far East, Hawaii) T : Europe E : Europe G : Germany V : China (Shanghai)  
 Y : AAFES(Europe) X : Australia Q : Russia H : Korea M : Other Areas Δ indicates safety critical components.

PARTS LIST

CD-3260M/3280M/DPF-J7020

\* New Parts

Parts without **Parts No.** are not supplied.Les articles non mentionnés dans le **Parts No.** ne sont pas fournis.Teile ohne **Parts No.** werden nicht geliefert.

⑨

Ref. No	Add-ress	New Parts	Parts No.	Description	Desti-nation	Re-marks
D38			HSS104A	DIODE		
D38			1SS133	DIODE		
D39			HZS5.1N(B2)	ZENER DIODE		
D39			RD5.1ES(B2)	ZENER DIODE		
ED1			16-MT-63GK	INDICATOR TUBE	E1	
ED1			16-MT-63GK	INDICATOR TUBE	K1P2T1	
ED1 ,2			16-MT-63GK	INDICATOR TUBE	KP1	
IC1			CXA1571M	ANALOGUE IC		
IC2			CXD2587Q	MOS-IC		
IC3			NJM2100M	IC(OP AMPLIFIER)	E1	
IC3			NJM2100M	IC(OP AMPLIFIER)	K1P2T1	
IC3 ,4			NJM2100M	IC(OP AMPLIFIER)	KP1	
IC5			NJM2115M	ANALOGUE IC	E1	
IC5			NJM2115M	ANALOGUE IC	K1P2T1	
IC5 ,6			NJM2115M	ANALOGUE IC	KP1	
IC7			NJM2100M	IC(OP AMPLIFIER)		
IC8			UPD784215GF541	MI-COM IC		
IC9			5M51008BFF70LL	MEMORY IC		
IC9			628128BLFP7SL	MEMORY IC		
IC10			UPD17215GT-737	MI-COM IC		
IC11			TC74HC00AF	IC(2INPUT NAND GATE)		
IC12			TA8409S	MOS-IC		
IC13			LB1930M	ANALOGUE IC		
IC14			UPD780204-038	MI-COM IC	E1	
IC14			UPD780204-038	MI-COM IC	K1P2T1	
IC14,15			UPD780204-038	MI-COM IC	KP1	
IC16			BA5979S	ANALOGUE IC		
IC19,20			NJM2100M	IC(OP AMPLIFIER)	KP1	
Q1			2SA954(L,K)	TRANSISTOR		
Q5 ,6			2SC3246(J,K)	TRANSISTOR		
Q7			DTC113ZSA	DIGITAL TRANSISTOR		
Q7			UN4219	DIGITAL TRANSISTOR	E1	
Q8			DTC124ESA	DIGITAL TRANSISTOR	K1P2T1	
Q8			DTC124ESA	DIGITAL TRANSISTOR	K1P2T1	
Q8			UN4212	DIGITAL TRANSISTOR	E1	
Q8 -10			DTC124ESA	DIGITAL TRANSISTOR	K1P2T1	
Q8 -10			UN4212	DIGITAL TRANSISTOR	KP1	
Q10			DTC124ESA	DIGITAL TRANSISTOR	E1	
Q10			DTC124ESA	DIGITAL TRANSISTOR	K1P2T1	
Q10			UN4212	DIGITAL TRANSISTOR	E1	
Q10			UN4212	DIGITAL TRANSISTOR	K1P2T1	
Q11 -14			2SA1576A(R,S)	TRANSISTOR	KP1	
Q11 -14			2SA1586(Y,GR)	TRANSISTOR	KP1	
Q11 ,12			2SA1576A(R,S)	TRANSISTOR	E1	
Q11 ,12			2SA1576A(R,S)	TRANSISTOR	K1P2T1	
Q11 ,12			2SA1586(Y,GR)	TRANSISTOR	E1	
Q11 ,12			2SA1586(Y,GR)	TRANSISTOR	K1P2T1	
Q15 -18			2SD1450(S,T)	TRANSISTOR	KP1	
Q15 ,16			2SD1450(S,T)	TRANSISTOR	E1	
Q15 ,16			2SD1450(S,T)	TRANSISTOR	K1P2T1	
Q19			2SK246(Y)	FET		
Q20			2SB1143(S,T)	TRANSISTOR		
Q21			2SC3940A	TRANSISTOR		
Q22			2SA954(L,K)	TRANSISTOR		

L : Scandinavia

K : USA

P : Canada

R : Mexico

C : China

I : Malaysia

Y : PX(Far East, Hawaii)

T : Europe

E : Europe

G : Germany

V : China (Shanghai)

Y : AAFES(Europe)

X : Australia

Q : Russia

H : Korea

M : Other Areas

Δ indicates safety critical components.

\* New Parts

Parts without **Parts No.** are not supplied.Les articles non mentionnés dans le **Parts No.** ne sont pas fournis.Teile ohne **Parts No.** werden nicht geliefert.

⑩

Ref. No	Add-ress	New Parts	Parts No.	Description	Desti-nation	Re-marks
Q23			DTC124EUA	DIGITAL TRANSISTOR		
Q23			UN5212	DIGITAL TRANSISTOR		
Q24			DTA124EUA	DIGITAL TRANSISTOR		
Q24			UN5112	DIGITAL TRANSISTOR		
Q25			2SB1417(P)	TRANSISTOR		
Q25			2SB1640	TRANSISTOR		
Q26			2SC2003(L,K)	TRANSISTOR		
Q27			DTA113ZSA	DIGITAL TRANSISTOR		
Q27			UN4119	DIGITAL TRANSISTOR		
Q29			2SC2458(Y,GR)	TRANSISTOR	KP1K1	
Q29			2SC2458(Y,GR)	TRANSISTOR	P2	
Q29			2SC3311A(Q,R)	TRANSISTOR	KP1K1	
Q29			2SC3311A(Q,R)	TRANSISTOR	P2	
Q30			2SA1048(Y,GR)	TRANSISTOR	KP1K1	
Q30			2SA1048(Y,GR)	TRANSISTOR	P2	
Q30			2SA1309A(Q,R)	TRANSISTOR	KP1K1	
Q30			2SA1309A(Q,R)	TRANSISTOR	P2	
Q31 ,32			2SA954(L,K)	TRANSISTOR	KP1	
Q33 ,34			DTC124ESA	DIGITAL TRANSISTOR	KP1	
Q33 ,34			UN4212	DIGITAL TRANSISTOR	KP1	
Q35			2SC2458(Y,GR)	TRANSISTOR		
Q35			2SC3311A(Q,R)	TRANSISTOR		
Q37 -40			2SD1450(S,T)	TRANSISTOR	KP1	
A1			W02-2561-05	ELECTRIC CIRCUIT MODULE		
A2			W02-1114-05	OSCILLATING MODULE	T1E1	
<b>MECHANISM CHANGER (MG-CH1)</b>						
1	1E		A11-1134-08	BASE ARM		
2	1E		D10-3788-08	LEVER R		
3	1D		D12-0158-08	CAM CHANGE		
4	1E		J19-5892-08	HOLDER ARM		
5	1E		G16-0912-08	RUBBER		
6	1E		D10-3778-08	ARM DISC		
7	1E		G01-4060-08	SPG DISC H		
8	1E		J21-6576-08	PLATE ARM		
9	1E		D10-3785-08	SLIDER RACK		
10	1E		J19-5891-08	HOLDER RACK		
12	1D		D10-3787-08	LEVER CHANGE		
14	1E,2D		T42-0920-08	MOTOR		
17	1D		D13-1856-08	GEAR D		
19	1E		D10-3781-08	LEVER HOOK A		
20	1E		D10-3782-08	LEVER HOOK B		
21	1D		D13-1857-08	GEAR E		
22	1D		S64-0038-08	LEVER SW		
25	1E		J21-6579-08	PLATE LIMITER		
26	2E		D10-3779-18	ARM SWING		
27	2E		D13-1855-08	GEAR CAM		
29	2D		J21-6573-08	PLATE LOCK		
30	2D		G01-4061-08	SPG LOCK LEVER		
31	2E		D10-3780-18	SLIDER CAM		
32	2E		J21-6574-08	PLATE SLIDE		
33	2E		D13-1854-08	GEAR SLIDER		
34	2E		D10-3786-18	LEVER STOPPER		
37	2E		J90-0854-08	GUIDE RACK		
38	1D		G01-4064-08	SPG CHANGE		

L : Scandinavia

K : USA

P : Canada

R : Mexico

C : China

I : Malaysia

Y : PX(Far East, Hawaii)

T : Europe

E : Europe

G : Germany

V : China (Shanghai)

Y : AAFES(Europe)

X : Australia

Q : Russia

H : Korea

M : Other Areas

Δ indicates safety critical components.

**HOW TO READ THE PARTS LIST**

**ABBREVIATION OF MODEL AND MASS PRODUCTION'S DESTINATIONS**

MODEL	ABB.	Australia	Canada	China	England	Europe	Germany	Korea	Malaysia
CD-3280M	-	-	P1	-	-	-	-	-	-
CD-3260M	-	-	P2	-	-	-	-	-	-
DPF-J7020	-	-	-	-	T1	E1	-	-	-
MODEL	ABB.	Mexico	PX/AAFES	Russia	Scandinavia	Shanghai	U.S.A.	Other area	
CD-3280M	-	-	-	-	-	-	K	-	-
CD-3260M	-	-	-	-	-	-	K1	-	-
DPF-J7020	-	-	Y1	-	-	-	-	-	-

\* New Parts

Parts without **Parts No.** are not supplied.

Les articles non mentionnés dans le **Parts No.** ne sont pas fournis.

Teile ohne **Parts No.** werden nicht geliefert.

11

Ref. No	Add-ress	New Parts	Parts No.	Description	Desti-nation	Re-marks
39	2D		D21-1899-08	PIN ROLLER		
40	2D		D14-0393-08	HOLDER ROLLER		
41	2D		J19-5888-08	ROLLER GUIDE		
42	2D		D21-1900-08	SHAFT MAIN		
43	2D		J19-5890-08	HOLDER SHAFT		
44	2D		J90-0856-08	GUIDE DISC		
45	1D		D32-0354-08	STOPPER DISC		
46	1D		J19-5893-08	HOLDER SENSOR		
47	1D		J19-5927-08	HOLDER SENSOR		
49	2E		J21-6570-08	PLATE HOLD T		
55	2E		J21-6580-08	PLATE LINK		
58	2E		J21-6571-08	PLATE SLIDER A		
60	2E		J21-6575-08	PLATE SUPPORT B		
62	2D		D13-1852-08	GEAR B		
63	2D		D13-1853-08	GEAR C		
64	1E		J90-0855-08	GUIDE DISC U		
65	2E		J19-5894-08	HOLDER DISC U		
67	2E		G01-4057-08	SPG SLIDER		
69	1E		G01-4062-08	SPG DAMPER A		
70	2E		G01-4063-08	SPG DAMPER B		
72	2E		G01-4065-08	SPG STOPPER		
73	1D		J19-5889-08	STOCKER ROTARY		
80	2E		J11-0840-08	CLAMPER		
82	2E		J02-1412-08	INSULATOR		
83	1D		E40-8285-08	CONNECTOR 5P		
86	2E		T99-0565-05	MAGNET		
87	1D		N29-0287-08	E-RING 6.0		
88	1D		N19-1458-08	PSW 8.5X16X0.5		
89	2D		N19-1460-08	PSW 8.5X30X0.5		
90	2E		J69-0083-04	DOUBLE COATED TAPE		
91	2E		T95-0160-08	PHOTO INTERRUPTER		
92	2E		E40-8284-08	CONNECTOR 5P		
94	2E		N19-1461-08	FLAT WASHER		
101	2E		D32-0360-08	PLATE STOPPER		
102	2E		G16-0936-08	SHEET		
-			B20-0623-18	SCALE		
LED			SIM-20ST	LED		
TR			RPM-20PB	TRANSISTOR		
R			RK73FB2A471J	CHIP R 470 J 1/10W		
<b>MECHANISM ASSY (D40-1515-05)</b>						
203	2A		D10-3606-08	ROD		
204	1B		D13-1720-08	GEAR		
206	3B		S74-0038-08	LEAF SWITCH		
208	3B		E40-3264-05	PIN ASSY		
DM	1B		A11-1082-18	SUB CHASSIS ASSY		
FM	2B		T42-0817-08	MOTOR ASSY		
PU	1A		T25-0061-08	OPTICAL PICKUP		

△

L : Scandinavia    K : USA    P : Canada    R : Mexico    C : China    I : Malaysia  
 Y : PX(Far East, Hawaii)    T : Europe    E : Europe    G : Germany    V : China (Shanghai)  
 Y : AAFES(Europe)    X : Australia    Q : Russia    H : Korea    M : Other Areas    △ indicates safety critical components.

**PARTS LIST**

**CD-3260M/3280M/DPF-J7020**

# CD-3260M/3280M/DPF-J7020

## SPECIFICATIONS

### CD-3280M

#### [Format]

System ..... Compact disc digital audio system  
Laser ..... Semiconductor laser

#### [D/A Convertors]

D/A Conversion ..... 1 Bit  
Oversampling ..... 8 fs (352.8 kHz)

#### [Audio]

Frequency response ..... 4 Hz ~ 20 kHz,  $\pm$  0.5 dB  
Signal to noise ratio ..... More than 97 dB  
Dynamic range ..... More than 94 dB  
Total harmonic distortion + noise  
..... Less than 0.005% (at 1 kHz)  
Channel separation ..... More than 92 dB (at 1 kHz)  
Wow & flutter ..... Unmeasurable Limit  
Output level/impedance  
Fixed ..... 2.0 V/0.9 k $\Omega$   
Digital output  
Coaxial ..... 0.5 Vp-p/75 $\Omega$

#### [General]

Power consumption ..... 14 W  
Dimensions  
W : 440 mm (17-5/16")  
H : 163 mm (6-7/16")  
D : 479 mm (18-7/8")  
Weight (Net) ..... 9.0 kg (19.8 lb)

### CD-3260M/DPF-J7020

#### [Format]

System ..... Compact disc digital audio system  
Laser ..... Semiconductor laser

#### [D/A Convertors]

D/A Conversion ..... 1 Bit  
Oversampling ..... 8 fs (352.8 kHz)

#### [Audio]

Frequency response ..... 4 Hz ~ 20 kHz,  $\pm$  0.5 dB  
Signal to noise ratio ..... More than 97 dB  
Dynamic range ..... More than 94 dB  
Total harmonic distortion + noise  
..... Less than 0.005% (at 1 kHz)  
Channel separation ..... More than 92 dB (at 1 kHz)  
Wow & flutter ..... Unmeasurable Limit  
Output level/impedance  
Fixed ..... 2.0 V/0.9 k $\Omega$   
Digital output  
Coaxial (For U.S.A. and Canada) ..... 0.5 Vp-p/75 $\Omega$   
Optical (Except for U.S.A. and Canada)  
..... -15 dBm ~ -21 dBm (Wave length 660 nm)

#### [General]

Power consumption ..... 13 W  
Dimensions  
W : 440 mm (17-5/16")  
H : 163 mm (6-7/16")  
D : 479 mm (18-7/8")  
Weight (Net) ..... 7.9 kg (17.4 lb)



1. KENWOOD follows a policy of continuous advancements in development. For this reason specifications may be changed without notice.
2. The full performance may not be exhibited in an extremely cold location (under a water-freezing temperature).

#### Note:

Component and circuit are subject to modification to insure best operation under differing local conditions. This manual is based on General market(M) standard, and provides information on regional circuit modification through use of alternate schematic diagrams, and information on regional component variations through use of parts list.

## KENWOOD CORPORATION

14-6,Dogenzaka 1-chome, Shibuya-ku, Tokyo, 150-8501 Japan

### KENWOOD SERVICE CORPORATION

P.O BOX 22745, 2201 East Dominguez St., Long Beach, CA 90801-5745, U.S.A.

### KENWOOD ELECTRONICS CANADA INC.

6070 Kestrel Road, Mississauga, Ontario, Canada L5T 1S8

### KENWOOD ELECTRONICS LATIN AMERICA S.A.

P.O BOX 55-2791, Piso 6 plaza Chase, Cl. 47 y Aquilino de la Guardia Panama, Republic de Panama

### KENWOOD ELECTRONICS BRASIL LTDA.

Av. Moema, 170-17", Andar-Cobertura "B", Ed. Maximum Service Center, 04077-020 Moema, São Paulo-SP-Brasil

### KENWOOD ELECTRONICS U.K. LIMITED

KENWOOD House, Dwight Road, Watford, Herts., WD1 8EB., United Kingdom

### KENWOOD ELECTRONICS BELGIUM N.V.

Meachelsesteenweg 418, B-1930 Zaventem, Belgium

### KENWOOD ELECTRONICS DEUTSCHLAND GMBH

Rembrücker Str. 15, 63150 Heusenstamm, Germany

### KENWOOD ELECTRONICS FRANCE S.A.

13 Boulevard Ney, 75018 Paris, France

### KENWOOD ELECTRONICS ITALIA S.p.A.

Via G. Sirtori, 7/9 20129, Milano, Italy

### KENWOOD IBÉRICA S.A.

Bolivia, 239-08020 Barcelona, Spain

### KENWOOD ELECTRONICS AUSTRALIA PTY. LTD.

(A.C.N. 001499 074)

P.O Box 504, 8 Figtree Drive, Australia Centre, Homebush, N.S.W. 2140, Australia

### KENWOOD & LEE ELECTRONICS, LTD.

Unit 3712-3724, Level 37, Tower 1, Metroplaza, 223 Hing Fong Road, Kwai Fong N.T., Hong Kong

### KENWOOD ELECTRONICS GULF FZE

P.O.Box 61318, Jebel Ali, Dubai, U.A.E.

### KENWOOD ELECTRONICS SINGAPORE PTE LTD.

No. 1 Genting Lane #02-02, KENWOOD Building, Singapore, 349544

### KENWOOD ELECTRONICS (MALAYSIA) SDN BHD.

#4.01 Level 4, Wisma Academy Lot 4A, Jalan 19/1 46300 Petaling Jaya Selangor Darul Ehsan Malaysia

### KENWOOD ELECTRONICS (THAILAND) CO., LTD.

2019 New Pechburi Road, Bangkapi, Huaykwang, Bangkok, 10320 Thailand